

electronics

radio, communication, industrial applications of electron tubes . . . engineering and manufacture



AUGUST
1 9 3 6

500 mc. tube in
construction
(316-A. See p.8)

Price
50 Cents

McGRAW-HILL
PUBLISHING
COMPANY, INC.

WHERE SPACE
IS AT A PREMIUM

use

STACKPOLE

**NEW SUPER MIDGET
TONE CONTROL**

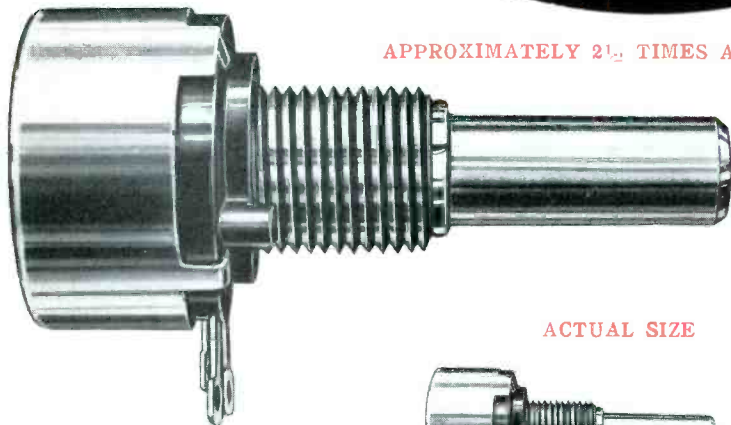

APPROXIMATELY 2½ TIMES ACTUAL SIZE

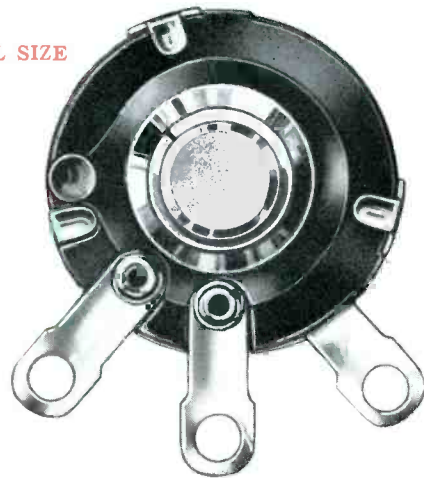

ACTUAL SIZE



THESE PRODUCTS ARE SOLD ONLY TO MANUFACTURERS OF ORIGINAL EQUIPMENT

WRITE for your sample Super Midget Control and Engineering data. One to four point tone switches are also available in the super midget size.

STACKPOLE CARBON CO.
ST. MARYS, PENNA.

*Manufacturers of quality resistors, suppressors,
switches, controls and tone switches*

August 1936 — ELECTRONICS

ELECTRONICS

radio, communication and industrial applications of electron tubes . . . design, engineering, manufacture

HOWARD EHRLICH
Vice-President

KEITH HENNEY
Editor

DONALD G. FINK
Associate Editor

H. W. MATEER
Manager

Contents • August 1936

COVER: *An expert glass blower sealing one of the new Western Electric 316-A triodes, which can deliver 6 watts at a wavelength of 60 centimeters in conventional negative grid circuits.*

NAB in Convention 7
News of the broadcast industry as revealed in Chicago

Theory of Electron Oscillators . . . 9
BY J. E. ANDERSON
A new explanation of the properties of positive grid (B-K and G-M) circuits

Cathode Ray Aircraft Compass . 12
BY SAMUEL OSTROLENK
A visual indicator of the CR type greatly improves performance of direction finders

U-h-f Signal Generator 16
BY C. J. FRANKS
20 to 100 mc. in a new instrument of countless uses in ultra-high frequency practice

Remote Tuning at KDYL 19
BY JOHN M. BALDWIN
Collecting short-wave press at a distance by ten-mile tuning, thus avoiding noise

Canadian Field Strength Measurements 20
BY H. M. SMITH
Methods used by the Canadian Radio Commission

Modulation Measurements 23
BY C. G. SERIGHT
Peak vs. r-m-s methods of evaluating modulation performance

Resistance-Coupling Data 25
BY GLENN KOEHLER
Gain of resistance coupled amplifiers for all audio frequencies, in chart form for reference use

Mean Level Determinations 27
BY G. H. LOGAN
Decibel chart for sound-power levels

Delay-Relay Circuits 28
BY D. E. NOBLE
Time discharge (RC) circuits for timing photographic printing, ringing class-room bells, etc.

DEPARTMENTS

Crosstalk 5 Tubes at Work 32 Manufacturing Review . . . 48
Reference Sheet 26 Electron Art 40 Index to Advertisers 61

Volume 9 . . . Number 8

ELECTRONICS, August 1936. Vol. 9, No. 8. Published monthly, price 50c a copy. Subscription rates—United States, \$5.00 a year. Latin America, \$5.00 a year. Canada, \$5.00 a year. All other countries, \$6.00 a year or 24 shillings. Application for entry as 2nd class matter at Albany, N. Y., pending. Printed in U. S. A.

Branch Offices: 520 North Michigan Ave., Chicago; 883 Mission St., San Francisco; Aldwych House, Aldwych, London, W. C. 2; Washington; Philadelphia; Cleveland; Detroit; St. Louis; Boston; Atlanta, Ga.

Contents Copyright, 1936, by McGraw-Hill Publishing Company, Inc.

McGRAW-HILL PUBLISHING COMPANY, INC.

Publication Office, 99-129
North Broadway, Albany, N. Y.
Editorial and Executive Offices
330 West 42d Street, New York, N. Y.

James H. McGraw, Jr.
Chairman
Howard Ehrlich
Vice-President

Malcolm Muir
President
B. R. Putnam
Treasurer

James H. McGraw
Honorary Chairman
D. C. McGraw
Secretary

Cable Address: MCGRAWHILL, New York. Member A.B.P. Member A.B.C.

OUTPUT CALIBRATION IN MICROVOLTS



—achieved by CLOUGH-BRENGLE at a revolutionary new low price



Dealer Net
\$43.90

Model NINETY-NINE R-f Signal Generator

Have You Tested
These New Models?

Beat Frequency Audio Generator

MODEL 79-A with greater spread on the lower frequencies and new stability achieved through improved circuit design and air trimming capacitors. Has type 6E5 tube as zero beat indicator. Uses low cost 6C5 metal tubes. Dealer net, with tubes\$53.75

Vacuum-Tube Voltmeter

MODEL 88 Combination Vacuum Tube Voltmeter and Peak Voltmeter. Reads 0-1.2 volts with input direct to tube grid (no shunts) on 4½ inch fan type meter. Supplies bucking voltage for peak voltage readings on scales of 0-10 and 0-100 volts. Dealer net, with tubes\$42.50

Constant Sweep Frequency Modulator

MODEL 81-A employs the C-B "Inductor-Sweep" to give plus and minus 20 kc wobble for calibrated selectivity curves, when used with any r-f signal generator. No alterations necessary on your generator. Dealer net, with tubes\$34.25

Cathode-Ray Oscillograph

MODEL CRA Cathode-Ray Oscillograph offers full facilities for all laboratory applications of this device. Built-in linear sweep with synchronizing circuit, amplifiers for horizontal and vertical inputs, and double the usual input sensitivity. Dealer net, with all tubes ...\$84.50 These or any other C-B Instruments will be sent for your test and approval without any obligation to purchase. Take advantage of this easy way to determine the usefulness of modern test instruments to your own laboratory.

Development of an improved r-f generating circuit with greater stability and linearity of output, now makes it possible for C-B to offer the lowest priced instrument ever to achieve direct microvolt calibration of r-f output. In addition, the MODEL 99 embodies numerous other advances such as:

Variable Percentage of Modulation: The depth of modulation, sine wave at all times, may be controlled from the panel, thus enabling the MODEL 99 to better meet the test requirements of modern a. v. c. and frequency "pull-in" circuits.

Direct Reading Dial: Over 100 common i-f broadcast and short-wave test frequencies are printed on the dial and their exact settings ruled in by hand, giving direct dial reading with ½ of 1% accuracy.

100 Kc to 60 Mc on Fundamentals: Divided between six ranges each having a complete separate inductor mounted on the rotating band change unit which eliminates the contact losses and multiplicity of wires necessary for ordinary band changing methods. Each band is tuned across

twenty-five inches of dial length, allowing extreme accuracy of setting.

Calibrated Attenuator: All r-f circuits are enclosed in both inner and outer shielding cases, with the r-f output being fed to cast aluminum attenuator. Each attenuation sector or range is contained in a completely isolated cast segment. Thus no r-f voltage carrying conductors are exposed, and strays are reduced to the low level necessary for testing receivers of the highest sensitivity.

The MODEL 99 will be ready for general delivery on or before September 1. Engineers desiring sample test units are invited to take advantage of the usual C-B test and approved plan which will bring you any instrument without obligation.

The CLOUGH-BRENGLE CO.

2811 W. 19th St.

Cable Address: CEBECO

Chicago, U. S. A.

Sales Offices in all Principal U. S. and Foreign Cities

*** POSITIVE UNIFORM INSULATION ***

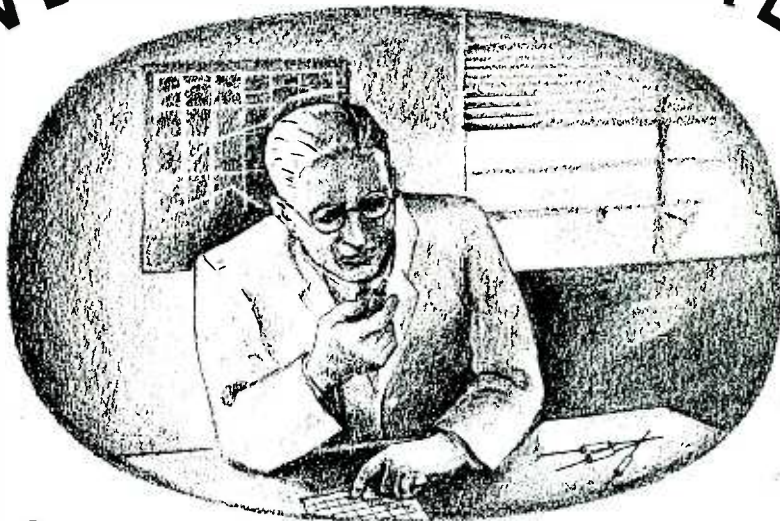

with Erie Insulated Resistors

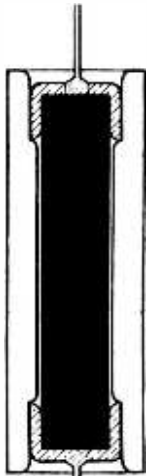

ENLARGED CROSS SECTION
3 TIMES ACTUAL SIZE

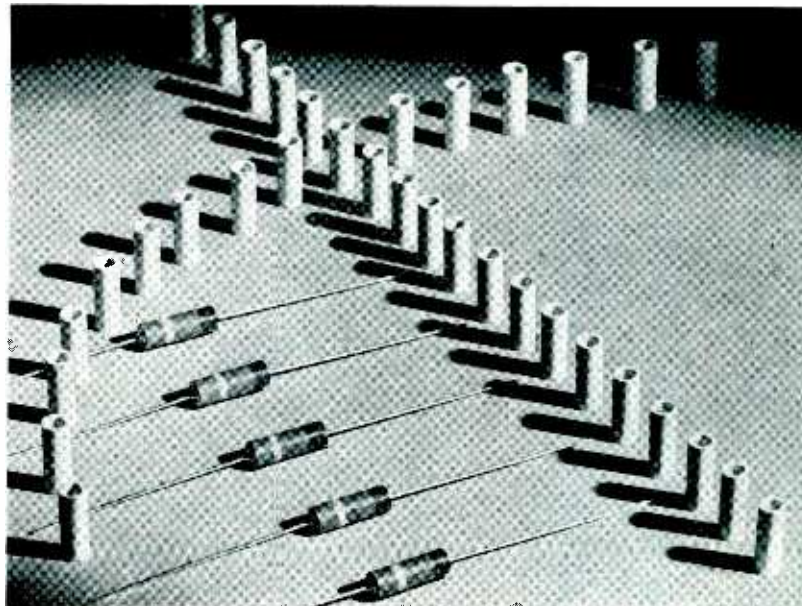

U.S. PATENT NO. 2,046,922
OTHER PATENTS PENDING

Erie Insulated Resistors are protected by a ceramic wall of unvarying thickness. Made to exacting specifications with tolerances as close as .005", these ceramic cases insure the same uniform insulation on every Erie Resistor of this type.



Laboratory tests show that standard production Erie Insulated Resistors will withstand over 3,000 volts A. C. before insulation breakdown occurs. This provides a large margin of safety against grounds and shorts in standard receiver installations.



ERIE RESISTOR CORPORATION
 MANUFACTURERS OF CARBON RESISTORS AND SUPPRESSORS AUTOMATIC INJECTION MOLDERS OF THERMO-PLASTICS
 TORONTO ERIE, PENNSYLVANIA LONDON

Save Production Time with **MALLORY** Standard Dry Electrolytic Capacitors

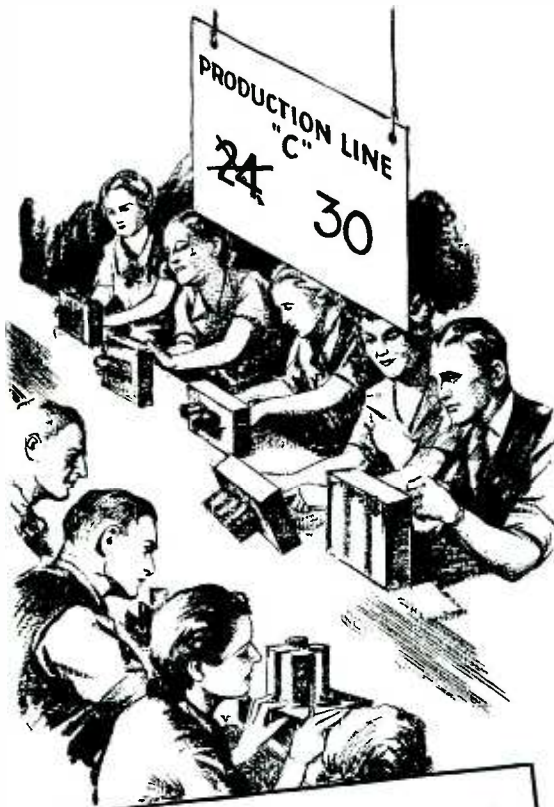

Two thousand rubber gloves constantly in use by the fabricators of Mallory Capacitors insure hospital cleanliness—a precaution taken to guarantee freedom from corrosion.



Of Course!

CELLOPHANE SEPARATORS
ETCHED ANODES
STITCHED ANODE LEADS

— All recent important improvements pioneered or developed by Mallory—are incorporated in Mallory Condensers wherever they add to quality and utility.

A single new Mallory standard combination capacitor (in a round metal can or a cardboard tube) will, in most cases, complete your electrolytic capacitor requirements.

Obviate the necessity for *several* individual capacitors! Dispense with punching extra chassis holes, buying or making extra mounting brackets!

Save Chassis Material Cost!

A new Mallory standard combination unit will reduce your capacitor expenditures by reason of a new method of standardization with consequent lowered production cost. Furthermore, extra cathode by-pass capacities may be included at slight additional expense.

Save Chassis Space!

With new Mallory standard combination capacitors, chassis space originally required for several units may now be otherwise utilized—or the entire chassis size may be reduced.

Mallory Capacitors provide extremely low RF impedance with unusually high by-passing efficiency, because of careful attention by Mallory engineers to internal lead arrangements and inductance effects.

These new Mallory units include concentrically wound combinations with as many as four sections. Special production methods provide excellent characteristics, more uniform performance—longer life. Capacity and voltage combinations to fit your circuit.

Mallory engineers will gladly assist in selecting the correct capacitors for your requirements.

MALLORY

DRY ELECTROLYTIC CAPACITORS

P. R. MALLORY & CO., Inc. INDIANAPOLIS, INDIANA

Cable Address—PELMALLO

ELECTRONICS

AUGUST
1936



KEITH HENNEY
Editor

Crosstalk

► **HAMS AT WASHINGTON . . .** On all sides we hear of the excellent presentation made at the FCC June UHF meetings by the amateurs. This is but natural. Most experienced of all users of the frequencies above 1500 kc. the amateur knows his stuff, and he contributed much to clarify the extensive loose talk at the meeting by those whose desire for allocations was based more on hope than on exact knowledge.

Most conservative of all groups in request for additional ether space, the amateurs want the harmonic band of 112 to 120 mc. and without shutting our eyes to the needs of other services, especially new governmental services, we believe the government should get their request. Having grown up as amateurs through the coherer, Electro Importing Company, spark and tube days our hearts are with the amateurs in spirit and practice. There is no more avid experimenter, no greater producer of concrete practical knowledge of methods or apparatus, no pioneer more eagerly looking for new frontiers than the "ham"—and probably no more useful citizen in case his experience and capabilities are ever called upon by the government.

► **TUBE LIFE . . .** In June we asked for experience on tube life, especially from industrial users. We quote below. "In the Center Theater, Rockefeller Center, Westinghouse installed a Westinghouse Ward-Leonard Hysterset control theater switchboard. There were 186 individual circuits with a rectifying tube in each circuit. These circuits were in use morning, noon and night during months of rehearsals and had been in service considerably over a year. This means an average of 15 to 16 hours per day service. The total cost of tube replacement for renewals has been \$30. In the Music Hall a Hysterset control replaced storage batteries and generator for telephone service for over a year, on continual service. There have been no tube failures."

Dr. Paul Weiller, Welding Timer Corporation (see *Electronics* May 1936) states: "We have been making welding control equipment for over a year and a considerable number of our units have been in operation for about that long, a good proportion of them on twenty-four hour service. Most of the others are working about nine hours a day continuously.

"Our timers are operated by two 27 tubes as control elements and two 80, 5Z3 and 83 as rectifiers. In one year, we have not had a single complaint from customers or a request to furnish new tubes. Several of the 83 tubes have given out. Because of the low cost and because failure can be easily noticed without resorting to test equipment, there has been no complaint. Of the other tubes, we have never heard.

"I assume, therefore, that the simple types of radio tubes made by prominent manufacturers if used conservatively have an actual life of several thousand hours. In a shop working

twenty-four hours a day, five days a week, five thousand hours are approximately a year's service. Add to this in a shop working only eight hours a day, five thousand hours are approximately three year's service. This is more than sufficient for radio tubes which can be purchased anywhere at a low price.

"Conditions are not quite so favorable when it comes to grid control rectifiers. These seem to have a life of about three thousand hours, occasional short life tubes being covered by a guarantee. The tube replacement cost of this type is therefore rather high. This is not very important for equipment controlling large powers. If there is three or four hundred dollars worth of tube replacement on a total equipment cost of say ten thousand dollars, this is not so serious. A tube replacement cost of sixty or one hundred dollars on equipment controlling only a few kilowatts, however, creates considerable sales resistance. We have, therefore, a peculiar condition that users of tube controlled equipment do not frown on the cost of the large tubes but seriously object to the cost of the smaller tubes.

"It would be very desirable to make the life of the mercury vapor types of tubes fifteen or twenty thousand hours even if their cost should be thereby increased. This period of service would approach the obsolescence period of the equipment and would be sufficient for all purposes."

► **HONORS . . .** Morris E. Leeds, president of Leeds and Northrup, internationally known as manufacturers of electrical measuring equipment, has received two signal honors recently. The Institute of Management gave him its Gant Medal for "distinguished achievement in industrial management" and Polytechnic Institute of Brooklyn made him Doctor of Engineering for "great service to society." A keen student of relations in industry, Mr. Leeds is widely known for his far-sighted philosophy of the factors which underlie harmony between employer and employee.



Morris E. Leeds, D.Eng.

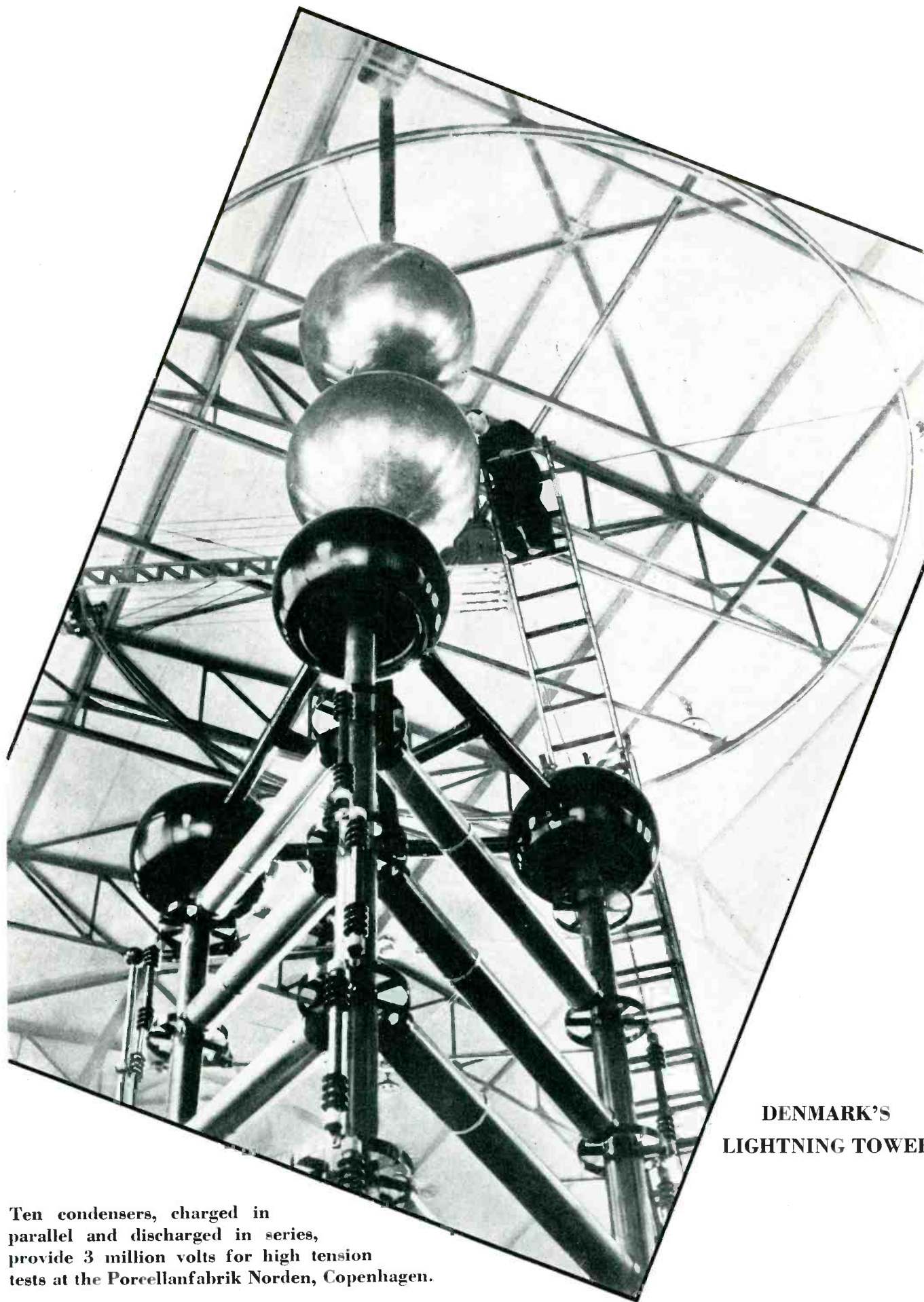

**DENMARK'S
LIGHTNING TOWER**

Ten condensers, charged in parallel and discharged in series, provide 3 million volts for high tension tests at the Porcellanfabrik Norden, Copenhagen.

NAB in Convention

National Association of Broadcasters avoids membership split, votes money for research, reappoints James W. Baldwin managing director, elects Charles W. Myers as president, discusses superpower, frequency allocation, new wavebands

CLOSING its annual meeting at Chicago on July 8, the National Association of Broadcasters may sum up the results of its convention as having stalled off an incipient split within its membership over the copyright (and other) questions, as having reappointed James W. Baldwin as managing director (at an increased salary), as having elected Charles (Chuck) W. Myers of KOIN and KALE as the new president.

Matters of great interest to the broadcast industry naturally were discussed at this convention. The following notes, augmented with technical data furnished by engineers closely associated with the art, will indicate the trend of these discussions and outline the present thinking of men identified with broadcasting.

Superpower

The anticipated increase in power to 500 kw. by several cleared channel stations was opposed by many other stations of all classifications. The Texas representatives were particularly strong in their opposition. A resolution to petition the Federal Communications Commission to grant no more superpower licenses was defeated in the Resolutions Committee and again in a general meeting. Such a petition was considered outside the proper field of the association, and many considered it useless to fight the inevitable. The situation resembled the bitter opposition in a 1924 meeting to the creation of high power stations, which at that time meant 5 kw.

At a meeting of the cleared channel group it was decided to oppose any limitation on the maximum power of cleared channel stations. A minimum power limit of 50 kw. was urged. The date for the FCC hearing on applications for 500 kw. has been postponed from September to

after the October hearing on reallocation. The stations known to be considering 500 kw. include KDKA, KFI, KNX, WBBM, WBZ, WGN, WHAS, WHO, WJR, WJZ, WOAI, WOR, WSB, and WSM.

Reallocation

Reallocation of frequencies is the next momentous technical question confronting the industry. At the last general reallocation in 1928, 90 per cent of the stations were changed in frequency. Since that date great technical advances have been made in radio, and it must now be determined whether public interest will best be served by another general reallocation.

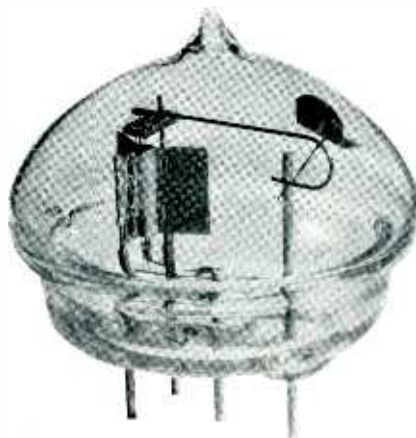

Western Electric 316-A tube de-scribed on page 8

Judge Sykes of the FCC addressed the convention, explaining the Commission's plans. He said, "The constant effort of the Commission has been to improve broadcast service to the listening public. A great step in this direction is through betterment of station broadcasting equipment. The Commission has no jurisdiction over receiving sets and can not prescribe standards for their production. I am informed, by engineers, that the transmission qual-

ity of broadcasting stations now surpasses the reception capability of a majority of broadcast receiving sets. I hope and believe that the set manufacturers will improve the fidelity of receiving sets."

A hearing on reallocation has been called for October 5th, and is expected to last about ten days. This hearing will deal with frequencies between 550 and 1600 kc. and will be similar in scope to the hearing held in June on ultra high frequency allocation. Subjects discussed in the hearing will include the future status of cleared channels, superpower, horizontal increase in power of regional stations, duplication of assignments, and possible opening of new classifications of stations. The Davis Amendment which has required the quota system in distributing radio facilities to states and zones was repealed by the last session of Congress, and the effects of repeal on allocation are not yet certain.

The most obvious improvement to be expected from a reallocation at this time is a better utilization of the lower frequency end of the broadcast band for covering large areas. The difference in the absorption of the ground wave at the two ends of the broadcast band is so great that a 50-kw. station at the low frequency end can serve an area many times as large as a 50-kw. station at the high frequency end. Within a few miles of the transmitter, there is only a slight difference in performance at different frequencies. Since there are large areas in the United States which must rely for service on stations several hundred miles away, it seems that the stations with location, power, and desire to serve these audiences should have the most favorable channels. This principle is already partially applied in the confining of local stations to frequencies

between 1200 and 1500 kc. The current plans to open broadcast channels above 25 mc. are an extreme application of this principle, but there is no prospect of these channels taking over any large part of local broadcasting service for at least three or four years.

The technical difficulties in putting a reallocation into practice are quite formidable; much more than they were in 1928. Many vertical radiators are in service, or will be by fall, and when a station is changed to such a high frequency that the radiator becomes much more than one half-wave-length long, it will not be usable. Such radiators must be shortened, or may be insulated and loaded to convert them into Franklin antennas. Where stations are assigned to lower frequencies, it is probable that the more desirable channels will be so welcome to the managements that there will be no objection to installing higher radiators.

Engineering Committee Report

The Report of the Engineering Committee was made by Chairman DeWitt of WSM. The advantages of a good antenna, which were stressed both in Mr. DeWitt's report and in Judge Sykes' talk were of particular interest to many station owners and managers, and lead to considerable discussion of the value of half-wave antennas, and means for determining whether a half-wave antenna is economically justified for a particular station. Judge Sykes stated that, based on the FCC survey, he believed that 50 per cent of the stations, by an improvement in antenna, could vastly expand their radio coverage without increasing power.

Mr. DeWitt also called attention to the fact that the improvement in frequency stability required in 1932 and the improvement in modulation performance being required this year are equivalent to increase of power of the station so far as service to the listener is concerned.

Research Proposed

A proposal made by Church of KMBC, as head of the Commercial Committee, was considered to be of great importance to the NAB. Mr. Church recommended creation of a cooperative bureau of radio research, to compile data on station coverage and listener habits. The proposed

project is to be a joint one between the radio broadcasting industry, radio advertisers, and advertising agencies. The important feature is that the findings are intended to be such that all three groups will accept them as authentic. It is intended to get more complete and authoritative data than is now available, and to eliminate disagreements in existing data due either to variations in methods of taking data or to personal interests of those for whom it is compiled. The greater part of the research will be of a commercial nature, but some of it will involve engineering. It is proposed that the research be done in a university for the sake of impartiality and economy, and the University of Pennsylvania is recommended for the commercial portion of it. The cost of the project is estimated to be \$50,000, which is half the annual gross income of the NAB. Similar work has already been begun with funds supplied by NBC and CBS.

Numerous manufacturers exhibited broadcast station equipment. Transcribed programs, transcription libraries, and transcription equipment are rapidly increasing in importance to broadcasters. The new studio equipment and transmitters differed not so much in fundamentals as in construction details and appearance.

Apparatus Displayed

A Fairchild-Proctor recorder was exhibited which makes records suitable for either immediate use or duplicating. It uses a piezoelectric cutting head, driven with about one watt of audio energy.

The UV-892 shown at the convention is a new water cooled tube used in 5 kw. transmitters. It has a center tapped filament intended for operating from two phase a.c.

New RCA speech equipment has many novel features, the most conspicuous being modernistic design. Individual meter lights are provided. Ventilation louvres have been converted into chromium panel ornaments. The front panels are hinged to give access to tubes, and the chassis is hinged so that it can be turned over to the rear for access to other parts. A particularly desirable feature is the fact that all parts are accessible without removing power or disconnecting any circuits. The volume indicator is designed to

give a very rapid rise and slow fall, which is considered necessary for proper control of level.

The most outstanding feature of the WE-Graybar exhibit was the demonstration and illustration with meters and a cathode ray oscilloscope of the new Doherty high-efficiency linear power amplifier. In this circuit, two tubes are used, one carrying no load when there is no modulation. The signal to one of the tubes is shifted 90 degrees ahead before being applied to the grid, and 90 degrees back after leaving the plate. Plate efficiencies of 60 to 65 per cent independent of modulation are obtained.

Several new transmitting tubes were shown. The 316A has a construction comparable with "acorn" tubes. It delivers 6 watts at 500 megacycles. The 304B is intended for operation between 30 and 300 mc. The anode of this tube has been changed from graphite to metal. Graphite proves unsatisfactory at such frequencies because of its high resistivity, and the fact that the higher frequency currents are confined more closely to the surface by skin effect. The 305A is a 25 watt amplifier intended primarily for police transmitters up to 60 mc. Very short leads from the screen and the center of the filament are necessary for this service.

Type 22A remote pickup amplifier and mixer shown weighs less than fifteen pounds. It may be used with either battery or a-c power supply. The new 23A input equipment contains everything necessary for a local station with two studios, and is constructed in a console for table mounting.

Collins Radio Company exhibited samples from their line of speech input equipment, transmitters, and transmitting tubes. Among their new items were type 12F speech input rack and a frequency control for broadcast transmitters. Type C-375A mercury vapor rectifier tube is suitable for 5 kw. transmitters. It can be used in many places where the larger 869 has been necessary heretofore.

The electron image tube and the electron multiplier of Dr. Zworykin described in *Electronics* in January 1936 and November 1935 were demonstrated at this NAB convention.

Theory of Electron Oscillators

A review of the Barkhausen-Kurz and Gill-Morrell circuits, and a new explanation of their oscillating peculiarities, of timely interest because of their ability to generate power at extremely high frequencies

AN OSCILLATOR employing a thermionic triode in which the grid is highly positive with respect to the cathode and the plate is at a low potential, which may be negative, zero, or positive, is called an electron oscillator. Such oscillators are usually operated at ultra-high frequencies. One of their characteristic features is that the generated frequency depends more on the grid potential and on the tube structure than on the impedance connected to the tube for the purpose of determining the frequency.

The first electron oscillator was brought out in 1920 by Barkhausen and Kurz. The wavelength generated by this circuit varied from 43 to 200 centimeters, and it was found to be related to the grid potential

the generated wave was not independent of the external impedance, but that it varied somewhat as expected. However, at certain values of the impedance the oscillation was most intense, and at these intensity maxima the generated wave was related to the grid potential in the manner found by Barkhausen and Kurz. Later Gill modified the formula to the form $\lambda^2 I_g / (E_g)^{3/2} = k$, which reduces to the original formula if the grid current, I_g , varies as the 3/2 power of E_g . Both the original and the modified formulas depend on the assumption that the plate potential is zero.

An electron oscillator which behaves according to the findings of Gill and Morrell is called a Gill-Morrell (G-M oscillator). In this paper, however, an oscillator of the Barkhausen-Kurz form in which the generated wave is independent of the grid potential and dependent only on the external impedance will be referred to as a G-M oscillator. As here defined, the B-K and the G-M oscillators are opposite extremes. No actual oscillator can belong exclusively to either type, but must be a compromise between the two, sometimes approaching one, sometimes the other. The reason for this is that the effects tending to produce the two types co-exist in every oscillator circuit. This will be discussed later.

Since Gill and Morrell various investigators have reached different conclusions regarding electron oscillators. Thus in 1924, Scheibe reported results similar to those of Barkhausen and Kurz, whereas in 1927, Tonks reported the results of mathematical investigations which supported the conclusions of Gill and Morrell.

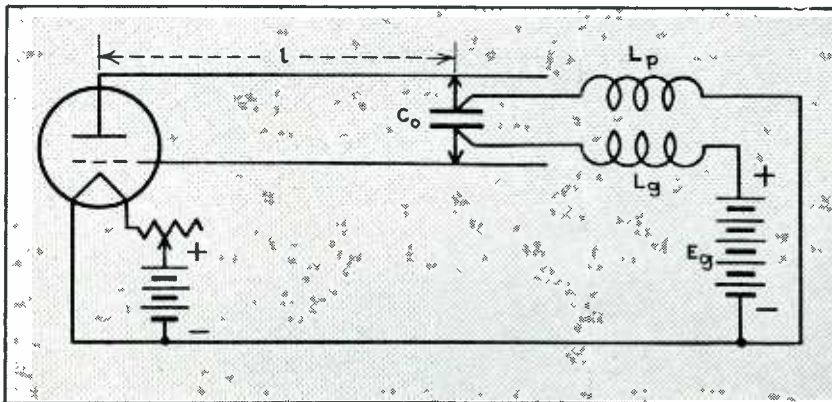

Fig. 1 (above) The circuit diagram of a typical electron oscillator

by the relation $\lambda^2 E_g = k$, where k is a constant. Apparently, the wavelength did not at all depend on the external impedance connected to the tube. An oscillator of this type will be referred to hereafter as a B-K oscillator. In 1922, Gill and Morrell, working with an oscillator similar to that of Barkhausen and Kurz, but covering a wavelength range from 200 to 500 centimeters, found that

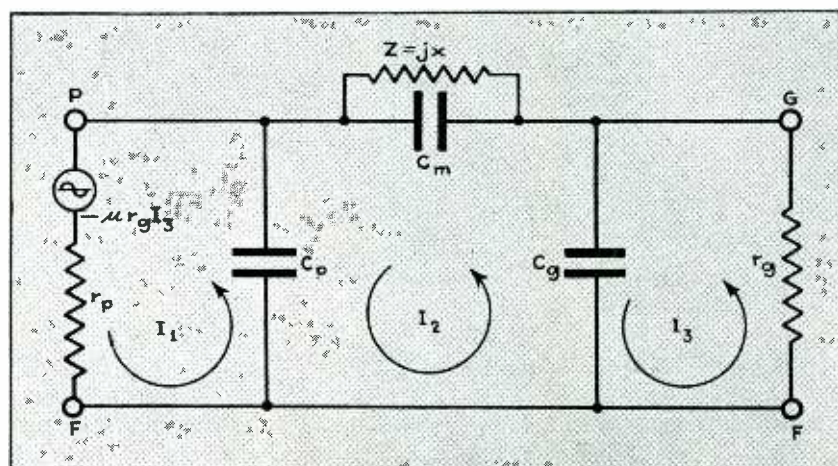

Fig. 2 (below) The equivalent circuit of the electron oscillator in Fig. 1

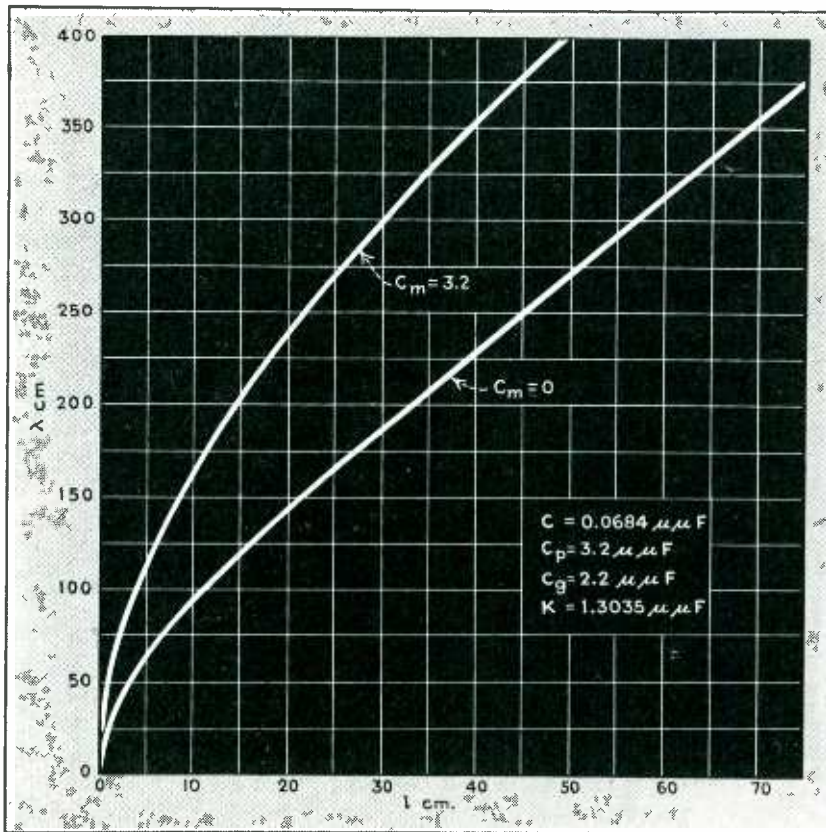

Fig. 3—Computed curves giving relation between length of Lecher wires and the generated wave in an Ultraudion with negligible effect of the grid and plate resistances

An important paper on the behavior of electron oscillators was brought out in 1929 by Hollmann, in which he showed that these oscillators would follow the G-M pattern for certain values of the external impedance and the B-K pattern for other values. The change from the G-M type to the B-K type, on increasing the length of the Lecher wires, was gradual and continuous. The change in the opposite direction, that is, from B-K to G-M, was sudden and discontinuous. Several of these discontinuities occurred along the Lecher wires. The absolute amount of the change in wavelength at each break depended on the grid potential and on the position along the wire at which the break occurred. The change in the wavelength varied from about 20 to 50 centimeters. The wavelengths obtained by Hollmann varied from 20 to 140 centimeters

In order to explain the existence of B-K oscillations investigators usually return to first principles and consider the forces acting on the electrons inside the tube, the distances they have to travel, and the dimensions of the elements. The "time of transit of an electron" from the cathode to the plate is also a consideration. The conclusion, as a

rule, is just the equation given by Barkhausen and Kurz and also by Gill and Morrell. That is, the wavelength squared multiplied by the grid potential is equal to a constant, provided the plate potential is zero.

This formula explains B-K oscillations very well, but it fails to explain the results of Gill and Morrell and also those of Hollmann. The formula does not admit any variations in wavelength as a result of changes in the external impedance. Neither does the theory of the uniform transmission line explain the iterative behavior of an electron oscillator as observed by Hollmann. If the oscillations were purely of the G-M type, there should be no jumping from one mode of oscillation to another but the wavelength should increase continuously as the length of the line is increased. While a transmission line can be excited in any one of its natural

modes of vibration by suitable impulses, it cannot oscillate in any but the first mode when it constitutes the frequency-determining impedance of a self-excited oscillator. That is, it cannot oscillate in any but the first mode unless there is some constraint internally or externally that forces it to oscillate in one of the higher modes. In the electron oscillators there is no external constraint, unless one is deliberately established, and therefore there must be an external one. What is it?

In order to find this constraint, it is necessary to return to the well-known theory of the conventional feed-back oscillators; for that theory suffices, provided only that no essential factors are omitted as being inconsequential. It is customary to omit the effects of the grid and plate resistances, but in electron oscillators their retention is imperative.

Aside from the fact that the ordinary oscillator theory leads to a satisfactory qualitative explanation of the behavior of electron oscillators, is there justification for applying this theory, approximate as it must be at best? Well, the circuit is the same as that of a conventional oscillator, the tube used remains the same even though the relative values of the grid and plate potentials are changed, and it should make no difference whether the power is supplied in the grid

circuit or in the plate circuit. Along this line it is interesting to quote Llewellyn.¹ After he has considered the forces acting on the electrons in a B-K oscillator he comments in conclusion: "It is interesting to note that the same kind of analysis here

used to illustrate the workings of the Barkhausen oscillator can be applied

* The Barkhausen Oscillator, Bell Laboratories Record, Vol. XIII, No. 12.

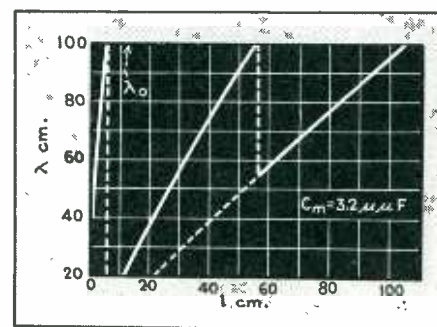

Fig. 4—Computed curves giving relation between length of Lecher wires and the generated wave when the product of the grid and plate resistances is low

to the well-known feedback oscillators operating with negative grid and positive plate, and shows that the two are not very different from each other after all. . . .” If that be true, the converse should also be true. That is, the theory ordinarily applied to the feedback oscillator should be applicable to the electron oscillator.

The circuit of a typical electron oscillator is given in Fig. 1. When this has been stripped of strictly d-c branches and when elements inherent in the tube have been added, the equivalent circuit may be represented as in Fig. 2. Here C_g , C_m , and C_p are the usual tube capacities; and they are assumed to be lumped at the end of the transmission line, the impedance of which is represented by Z in shunt with C_m . The grid-cathode and plate-cathode resistances are represented by r_g and r_p , respectively. All other resistances will be neglected. For convenience the impedance of Z and C_m in parallel will be denoted by Z_s . Impedance symbols will be retained for brevity until reactances are needed.

It will be noticed that the equivalent circuit is that of a simple Colpitts, or more particularly, the Ultraudion form of the Colpitts. Hence any conclusions drawn from the analysis of Fig. 2 will apply equally well to any simple Colpitts. It is understood that Z need not necessarily be the impedance of a transmission line.

The circuit can most easily be solved by treating it as an amplifier that feeds itself, and then computing the amplification. As soon as the steady state has been reached, the amplification must be identically unity, for there can neither be a change in amplitude nor in phase. On this basis the solution is readily effected by solving for one of the assumed currents, say I_3 , in terms of itself and of the circuit parameters.

By summing up the voltage drops in the three meshes we have:

$$\begin{aligned} -\mu I_3 r_o &= r_p I_1 + (I_1 - I_2) Z_p \\ 0 &= (I_2 - I_1) Z_p + Z_s I_2 + (I_2 - I_3) Z_o \\ 0 &= (I_3 - I_2) Z_o + r_s I_3 \end{aligned} \quad (1)$$

The solution of these three simultaneous equations for I_3 yields, after I_3 has been canceled out, the equation:

$$-\mu r_o Z_p Z_o = (r_p + Z_p) Z_s (r_o + Z_o) + r_p Z_p (r_o + Z_o) + r_o Z_o (r_p + Z_p) \quad (2)$$

This is the complex condition for

oscillation in the circuit. The real part is the amplitude condition and the imaginary part the phase condition. They must be true simultaneously. Since all the impedances have been assumed to be pure reactances, the two conditions may be written:

$$\begin{aligned} -\mu r_o Z_p Z_o &= r_p Z_o Z_s + r_o Z_p Z_s + r_p Z_p Z_o + r_o Z_p Z_o \quad (3a) \\ r_p r_o (Z_p + Z_s + Z_o) &+ Z_p Z_s Z_o = 0 \quad (3b) \end{aligned}$$

When reactances are inserted in 3a it reduces to,

$$r_m = (r_p C_p + r_o C_g) X_s \omega \quad (4)$$

in which $r_m = \mu r_g + r_g + r_p$ and ω is the frequency of the oscillation in radians per second. Since all the resistances are positive, this equation

This ω_o is of prime importance in an electron oscillator. By definition it is the geometric mean of the time constants of the end meshes of Fig. 2. By equations (4) and (5) it is the lowest frequency at which the circuit can oscillate, which holds for any Colpitts. It is the frequency, in radians, of the pure B-K oscillator and the frequency at which the Gill and Morrell circuit oscillates most intensely. It is also the frequency at which the Hollmann oscillator jumped from the B-K type to the G-M type. The condition $\omega \geq \omega_o$, obtained from (4) and (5), is the internal constraint that is necessary to force the circuit to oscillate at the higher modes.

The effect of ω_o is present in all

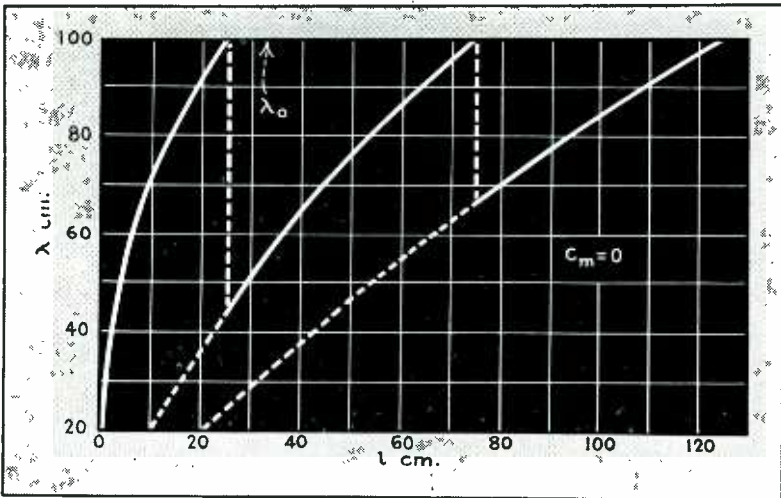

Fig. 5—Curves similar to those in Fig. 4 but computed on the assumption that the grid-to-plate capacity, C_m , is zero. The solid lines represent regions of oscillation

can be satisfied only by positive values of X_s . This means that oscillation can occur only if the impedance between the grid and the plate is inductive. This holds true for all Colpitts oscillators. Whereas X_s is restricted only to positive values, X is much more restricted. Since the line reactor is in shunt with C_m , we have $X_s = X / (1 - X\omega C_m)$. Thus X is hemmed in by conditions $0 < X < 1 / C_m \omega$.

By introducing reactances in (3b) it may be reduced to the form

$$X = \frac{1}{\omega(C_m + K - K\omega^2/\omega^2)} \quad (5)$$

in which K is the capacity of C_p and C_g in series and ω_o is defined by the equation

$$\omega_o^2 = \frac{1}{C_p C_g r_p r_g} \quad (6)$$

Colpitts oscillators, unless it should happen that either r_p or r_g is infinite, for then ω_o is zero. However, in most feedback oscillators the limiting frequency is so low that it affects the oscillation frequency only to a negligible extent. But when a tube is operated so that for any reason $r_p r_g$ is low, ω_o becomes high. It may easily become higher than the natural frequency of the tuned circuit that is supposed to determine the frequency. In that case the circuit refuses to oscillate, except, perhaps, at an ultra-high, "parasitic" frequency. The condenser in the tank circuit then merely acts as a short at the end of an accidental line, just as C_o acts as a short in Fig. 1.

The reason why Barkhausen and Kurz on the one hand and Gill and

[Continued on page 46]

The Cathode-Ray

Use of a fluorescent screen as an indicator for radio direction finders overcomes many serious disadvantages of other instruments, permits accurate night flying

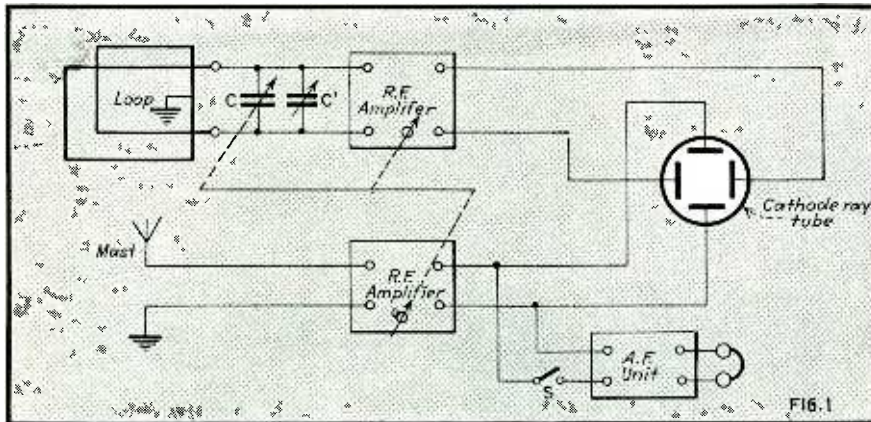

1 Fundamental circuit of the compass, showing how the loop and stationary "mast" voltages are applied to deflecting plates

BY SAMUEL OSTROLENK

New York, N. Y.

RECENT aircraft disasters have focused attention upon the serious need of an absolutely reliable and foolproof radio-directional guidance for aircraft. Although the reliability of the loop antenna for directional indication is well-known, the requirements for aircraft radio directional apparatus differ vitally from established land or marine equipment.

One of the first developments of an automatic on-course indicator for the pilot was the A-N beacon system. The disadvantages of the system are well-known. If the beam is accidentally lost, it is difficult to return to the predetermined course. The pilot has to depend upon special beacon stations and special courses of flight.

In the article "Flying the Pacific by Radio" (*Electronics*, April 1936, page 7) there is described an elaborate directional system employed by the Pan American Airways for their Clipper ships. Signals transmitted by the aircraft are picked up by two separate ground stations. The position of the craft is calculated and transmitted to the pilot at regular

intervals to apprise him of his course. Accurate determinations by this system prove the reliability of the null type direction finder.

However, very few planes can command such elaborate ground facilities to guide their flight. The trend has been toward a self-contained, light weight equipment which automatically determines the direction toward a radio station and automatically indicates the deviation of the aircraft to the right or to the left of the on-course direction. The presentation "Aircraft Radio Compass" (*Electronics*, Oct. 1935, page 7) describes the details of a radio compass extensively used today. The basic principle underlying these devices, invented by Dieckman and Hell in 1925, depends upon properly phasing the received signals by a loop and a non-directional antenna to produce the cardioid reception patterns (page 9) and actuate an indicator to the right or left of a zero null position in accordance with the orientation of the loop antenna and the signal wave front.

The fundamental faults of this system are adequately summarized in

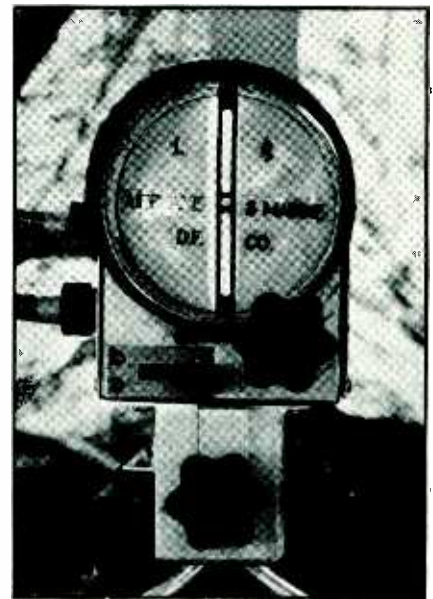

A. On course. The voltage from the loop is zero



2 C. Circle image showing plane directly over towers of station

a report of the Radio Technical Committee for Aeronautics, published on pages 163-164 of *Air Commerce Bulletin* of January 15, 1936.

1. The indicated bearings of a satisfactory radio direction finder should depend upon the angular relation of the loop with respect to the transmitting station only and should not depend upon critical phasing of the electrical circuits. We believe that the lack of this feature in the present equipment, which requires accurate adjustment of circuits, is the

Aircraft Compass

Lissajou figures formed by loop and stationary antennas give course indications accurately. Phase errors immediately detected and corrected

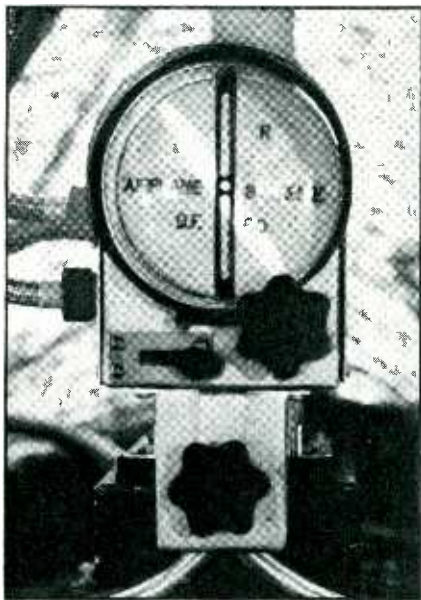

B. Indication when off-course to left

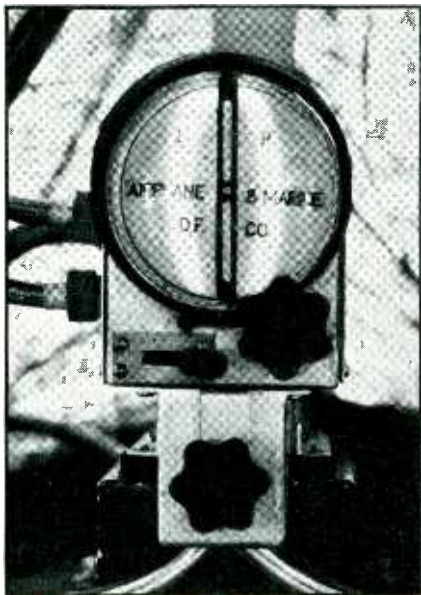

D. Elliptical pattern showing improper phase adjustment

principal disadvantage of these units.

2. A direction finder, to be satisfactory, should be free from course errors resulting from interference by other stations on adjacent channels.

The cardioid reception pattern radio compass system requires accurate adjustment of the antenna circuits, particularly the phase relation between the loop and the non-directional antenna. Periodic electrical servicing of the equipment is necessary and the pilot has no indication during flight that his radio

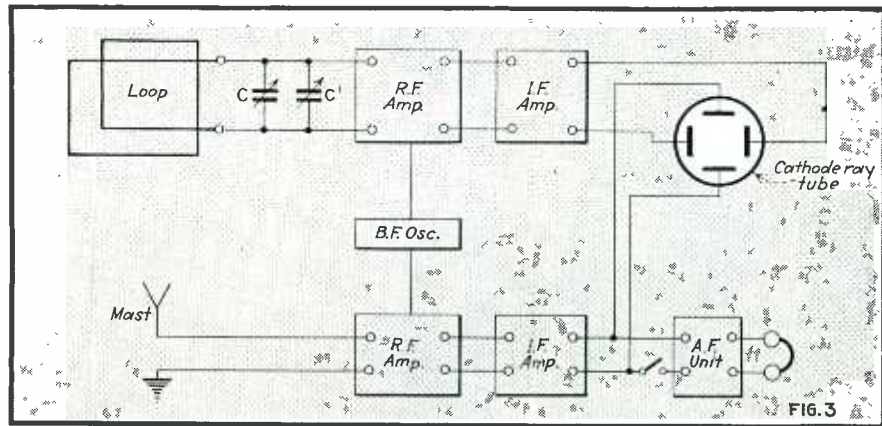

3 Improved circuit using superheterodyne principle, which prevents inter-coupling

compass circuits are in proper relation. Flight errors up to ten degrees and more are attributable to mis-phased conditions over which the pilot has no control. When it is realized that the electrical parameters of the loop antenna do not remain constant, but change in accordance with temperature, humidity and mechanical vibration or shock, it will be evident that the absolute reliability of the cardioid system is impossible. Temperature variations in flight of two degrees Fahrenheit per minute are usually incurred and serve to destroy the phasing characteristics for the cardioid reception pattern and in turn destroy the accuracy of the indications. A mis-phased condition will prevent a 'null' indication when on-course. Mistuning of the loop circuit is another serious factor for misphasing and the pilot generally has no means for realizing this condition. Slight mistuning errors cause directional errors of two to four degrees.

A right-left indicating direction finder, operating on a radically new principle, for which patents are pending, has been invented by Edward J. Hefe. This device employs a cathode ray tube as a means of visual indication. Several models, manufactured by the Airplane and Marine Direction Finder Corporation, of

which Mr. Hefe is Chief Radio Engineer, have been submitted to the U. S. Coast Guard. This direction finder has been tested extensively under various flight conditions under the supervision of Chief Radio Electrician C. T. Solt of the Communications Division, Coast Guard Headquarters, Washington, D. C., which division functions under the immediate jurisdiction of Commander F. A. Zeusler, Chief Communications Officer. Mr. Solt, accompanied by Coast Guard pilots J. R. Orndorff and W. R. Durham conducted numerous test flights over bodies of water as well as over flat, hilly and mountainous terrain during daylight and darkness. During these tests it was noted that night effect, although evident by the character of the cathode ray pattern, did not materially affect the directional accuracy. Flights through heavy atmospheric disturbances, which would preclude any other type of radio compass have been made 'blind' by this cathode ray right-left indicator with excellent results."

The basic improvement of the Hefe system resides in combining independently amplified directional and non-directionally received signals at the indicator, which is preferably a cathode ray tube, in a manner which continuously appraises the pilot

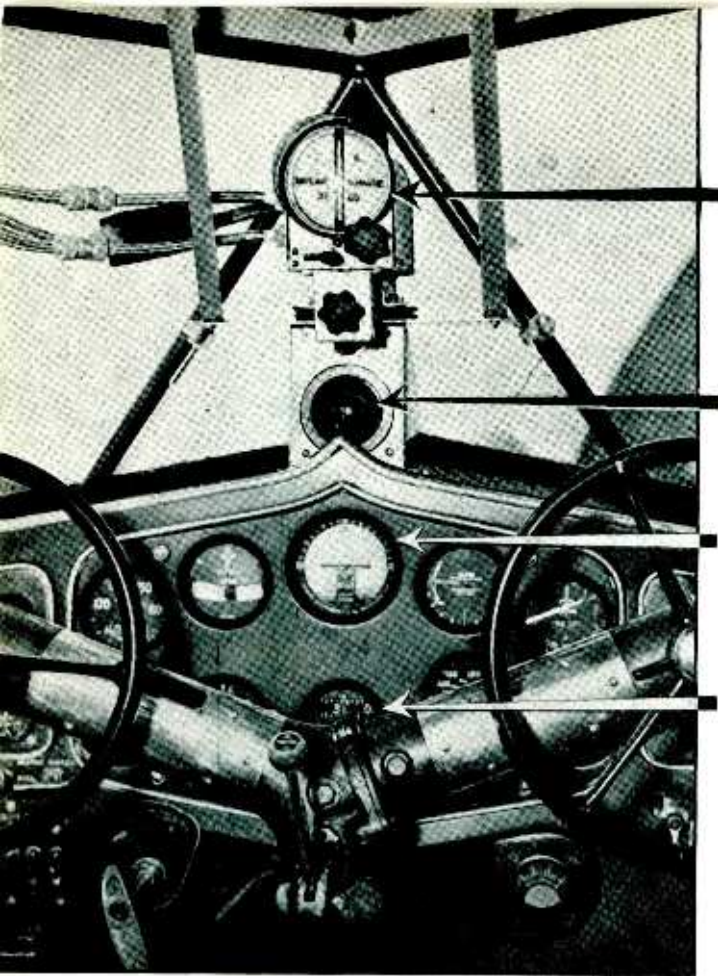

The CR compass in the Coast Guard plane. Note vertical arrangement of navigation instruments

Magnetic compass

Artificial Horizon

Directional gyro compass

of all the necessary information which he needs for reliable directional guidance.

Figure 1 is a simplified schematic representation of the electrical circuit of this new radio compass. The radio station is tuned in by means of a common tuning control. The non-directional antenna is preferably a vertical mast located upon the exterior of the aircraft. The mast signals are amplified by a corresponding radio frequency amplifier, the output of which is connected to the vertical deflecting plates of a cathode ray tube. The loop antenna is tuned by the variable condenser *C* and is connected to the input of the loop radio frequency amplifier. The loop signals are connected to the horizontal deflecting plates of the cathode ray tube. Continuous aural reception is feasible by closing switch *S*, connecting the audio detector and amplifier to the output of the non-directional radio frequency amplifier.

The mast signals produce a vertical image of predetermined amplitude upon the fluorescent screen. The loop signals impressed upon the horizontal deflecting plate, being of the same wave shape as the vertical plate signals, act with the vertical image to produce a resultant image (Lis-

sajou figure) upon the fluorescent screen of the cathode ray tube according to principles well known. The deflection of the image from vertical is dependent upon the relative intensity of the loop or directional signal component. A straight line image results when the vertical and horizontal deflecting plate signals are in phase. Otherwise, an ellipse appears on the screen (see Fig. 2). Since the wave shape of the component signals is the same, a stationary image results. The ellipse shows evidence of misphasing between the two component signals. By adjusting the vernier condenser *C'* connected in parallel across the loop antenna, the relative phase of the loop signal is changed and is brought into coincidence at the cathode ray tube with the vertical mast signals as evidenced by the straight line image upon the cathode ray screen.

The horizontal component signals impressed upon the cathode ray tube due to the loop antenna causes the null reference vertical indication to deflect to the right or to the left as illustrated in Fig. 2. The angle of deviation depends upon the relative intensity of the loop component.

If the plane of the loop is perpendicular to the wave front of the re-

ceived signal, a zero or null signal condition exists therein. By positioning the plane of the loop perpendicular to the axis of the plane, a null loop signal condition will provide homing flying. If the plane deviates to the left or to the right of the on-course path, the loop antenna will be impressed with corresponding signals to deflect the normal vertical indication (due to the mast antenna system) to the right or the left. The angle of deviation depends upon the sensitivity adjustment of the loop amplifier and also upon the angle of deviation of the aircraft from its course.

The pilot tunes to a radio station in the vicinity of his destination by means of the audio unit, and maintains his flight directly towards the station by manipulating his controls to keep the deflecting fluorescent image vertical. The vertical indication of a normally functioning instrument accurately determines when the plan of the loop antenna is perpendicular to the wave front of the received signals.

Failure of either amplifier unit is immediately ascertained by the pilot by absence of the corresponding component of the indication image. The bearing accuracy of the system depends only upon the physical position of the loop antenna with respect to the transmitting station and is independent of critical phasing or amplification ratios of the electrical equipment.

A misphased condition between the directional and non-directional antenna systems is immediately evi-



Stream-lined loop for the new compass

dent as an elliptic image and can be immediately corrected by the tuning vernier *C'*. However, it is to be noted that the automatic directional indication is independent of the mis-phased conditions, even though an elliptic image is produced, since its axis is deflected similarly to the corresponding straight line image.

The tuned radio frequency amplifier system illustrated in Fig. 1 causes signals of corresponding radio frequency to be impressed upon the cathode ray tube and special precautions must be taken to avoid inter-coupling reactions. Fig. 3 illustrates a more practical modification utilizing superheterodyne reception. A common beat-frequency oscillator is employed with independent antenna r-f amplifier sections. The resultant intermediate frequency signals are accordingly of identical frequency and wave shape due to the common beat-frequency oscillator. The output of the i-f amplifiers are impressed upon the corresponding deflecting plates of the cathode ray tube. The principle of operation of the superheterodyne modification in Fig. 3 is identical to that of Fig. 1 with the added advantage of higher stable amplification and in arrangement of circuits.

It is important for the pilot to know whether he is flying towards or away from the station even though he is on-course on the beam. The cathode ray tube direction finder provides such automatic sense directions in the following manner: When the plane deviates to the right of the course, the deflection of the fluores-

Receiving unit installed in the plane

Loop control wheel for taking off-course bearings

Receiving control unit for tuning, phase adjustment, audio output

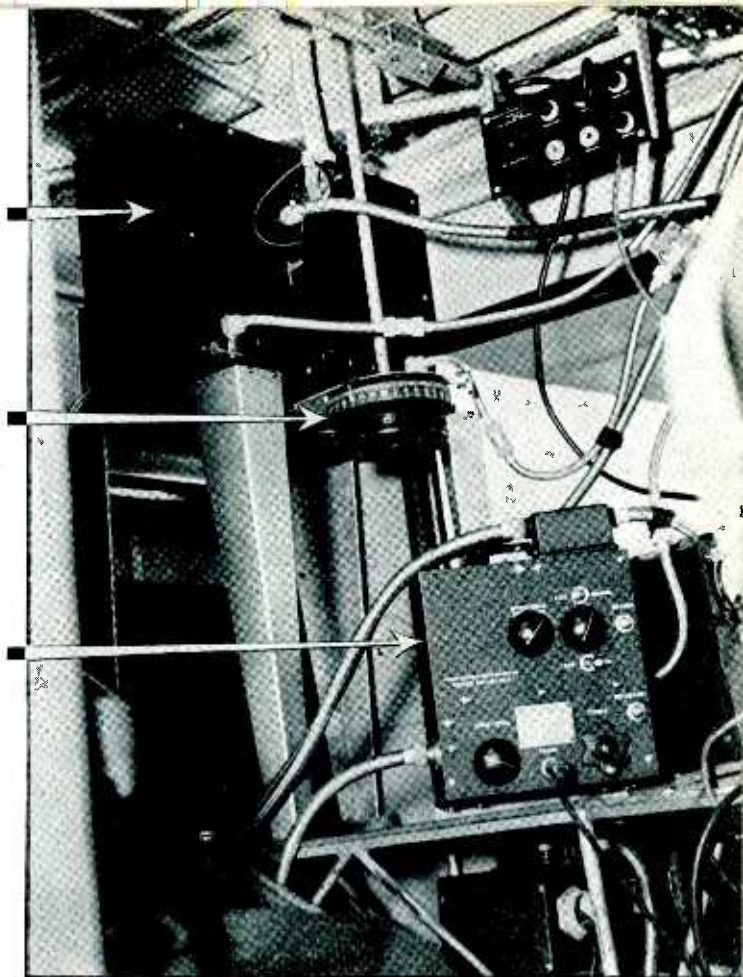

cent image will be to the left or reversed to the normal condition. This reversed effect is due to the reciprocal or opposite position of the incoming signal waves with respect to the predetermined orientation of the loop antenna. The signals are accordingly 180° out of phase and produce an inverted sense indication on the indicator.

The pilot is immediately apprised of reversed flying. When he deviates to the right of on-course and the indicator deflects to the left of the null reference indication, the pilot normally believes himself to be flying at an angle to the left of the beam. He accordingly controls his plane to turn more toward the right to bring him from his apparent left position to on-course. However, due to his reversed bearing, the deflection will deviate still more towards the left. The pilot accordingly immediately knows that he is flying away from the beam. It may be sometimes convenient to fly on "reversed sense" when flying away from a beacon or transmitting station. This is accomplished by merely reversing the terminals of the loop to the input of its radio frequency amplifier by a simple reversing switch.

This indicator will also give a

direct indication when the aircraft is directly over a transmitting antenna. In flight over the antenna, the indicator sense will change from normal to reversed. However, when directly over the station, the vertical indication broadens to an ellipse and then to a distinctly circular image which moves slowly off center. When the over-station position is passed, the vertical line on-course indication returns but with reverse sense. Continued flying with proper sense is accomplished by the loop reversal switch.

Hefe's cathode ray right-left indicator may be used to indicate the direction of any type of radio station, such as a broadcasting station, radio beacon of the A-N type and commercial or telegraph stations. ICW telegraph signals may be read directly on the indicator since the image line will appear and disappear in accordance with the telegraph signals. However, the deflection of the image is unaffected by the ICW and accordingly the directional accuracy is maintained. Continuous aural reception of weather reports, flight instructions and the like are feasible while maintaining continuous directional indication on a cathode ray

Continued on page 45



The drag is two pounds at 200 m.p.h.

20-100 mc. Signal Generator

Allwave receivers now tune as high as 40 to 60 megacycles. To engineer and test them and other apparatus in the UHF region calls for a generator with characteristics not found in the broadcast band

THE modern allwave receiver is a pretty marvelous machine. Tuning over the range from 0.5 to 30 mc., any frequency in that range quickly and easily selected, sensitive enough to reach noise level in most locations, selective, and reproduced in quantity at a surprisingly low price, it presents a striking contrast to the insensitive, hard-to-tune, unselective, expensive receiver of a few years ago. Receiver design has gone ahead at an amazing rate in the last ten years, chiefly because we have learned how to measure what we are doing.

There never has been any substitute for a signal in receiver testing. The most convenient source of such signals is the signal generator. Placed on the bench in front of the engineer, it is in effect a complete distant transmitter, operating with the type of transmission he wants, at any hour of the day or night, transmitting on any desired frequency with any desired signal strength, and with all of these factors under control. With it he can make performance tests, compare one receiver with another, trace down defects, study the effect of design changes. Without its aid we should still be a long way from the perfected allwave receiver of today.

But the "allwave" receiver is not truly all-wave. It goes up to per-

By C. J. FRANKS

*Ferris Instrument Corporation
Boonton, N. J.*

haps 20 mc.; some go higher, but not very satisfactorily. Now we know that above 20 mc. is a region of great potential usefulness. Transmission characteristics are beginning to be known, antenna design is well advanced, and transmitters can be built for almost any desired amount of power at frequencies up to perhaps 100 mc. And there is an enormous number of channels available—yet this frequency region is little used. Why?

Largely because we have no satisfactory receivers for use on the higher frequencies. For proof look at the number of freakish, unsatisfactory attempts which have been made and still are being made to design ultra-high-frequency receivers. There is always the old standby, the superregenerator, but that is scarcely a solution.

The superheterodyne is a usable circuit, but to realize the possibilities of this type a good signal generator is required. Even the mere aligning and tracking of a UHF superheterodyne is almost impossible without at least a test signal of some sort.

The difficulty of building a good and useful UHF generator does not, strangely enough, lie in the internal design of the instrument itself, although such a generator is much more difficult to build than one for use at lower frequencies. The first generators for the high frequencies were built several years ago, and the model described here differs only slightly from those earlier models. The real difference lies in the method used to connect the generator to the receiver to be measured. The principal difficulty with earlier gener-

ators, and one which kept them from being usable, was the lack of proper provision for this connection. Although the correct microvoltage might actually appear at the output terminals of the instrument, there wasn't any way of making use of it. When the usual connecting means were used, strange and unaccountable things happened, and measurements didn't mean anything. When a pair of leads becomes comparable in length to one-quarter of a wavelength, which can easily happen above 30 mc., the voltage at one end usually bears very little relation to that at the other end, sometimes being ten times as much, and sometimes as little as one-tenth.

The magnitude of the lead step-up effect and the surprisingly low frequencies at which it can become important are shown by the curves of Fig. 1 taken on a typical setup, the generator and receiver being connected by leads three feet long. The termination at the receiver end was a tube grid. The largest error shown on the curves is only 8 to 1, but in some special cases errors as large as 25 to 1 have been found in the same frequency region. Since a slight change of load capacitance, load power factor, or lead configuration will produce large changes of step-up at the critical frequencies, measurements can seldom be repeated or checked and the engineer ends up with a hopeless feeling and a complete loss of confidence in signal generators.

On going to higher frequencies the natural thing is to shorten leads, to eliminate errors, but this usually proves disappointing. In the case shown in Fig. 1, shortening the leads to six inches raised the resonant frequency to only 55 mc., due to the residual self-inductance of about 0.1 microhenry within the signal-gener-

Setup for Fig. 2 on page 18

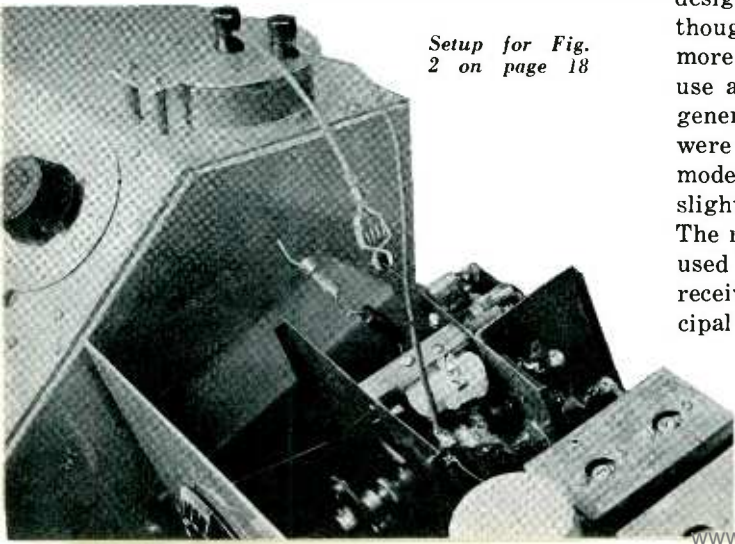

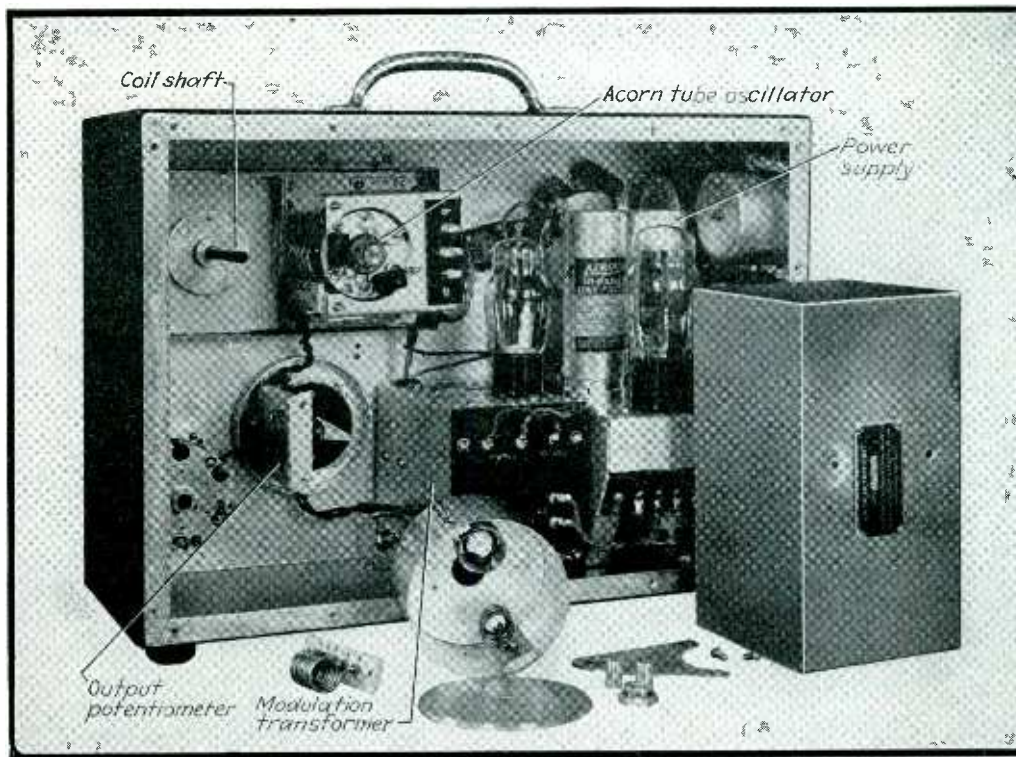

Left

Signal generator
"knocked down"
to show
components

Below

Generator connected
to receiver
under test

ator proper. To be successful at frequencies above about 50 mc. it is essential not only to reduce the residual inductance of the generator to the vanishing point, but to reduce the connecting leads to something under about two inches in length.

It is not too difficult to accomplish the first requirement—that is only a design problem—but the second is harder. Leads less than about a foot long seriously cramp the style of the user, yet these are too long for accuracy. Next was tried a setup of an experimental signal generator and an experimental superheterodyne receiver, both covering the range 50 to 75 megacycles. They were placed on the test bench as close together as was possible and connected with a ground lead six inches long and a high potential lead twelve inches long. Figure 2 shows the results of measurements made with this setup. The measurement is that of antenna circuit voltage gain, made in the usual manner by determining the microvolts input for standard output with the generator connected alternately to antenna terminals and to the first grid, the ratio of these values being the voltage gain. Curves A and A' were taken with the setup shown. Of course it is highly improbable that such curves could be correct, particularly the one of voltage on the grid (A') which

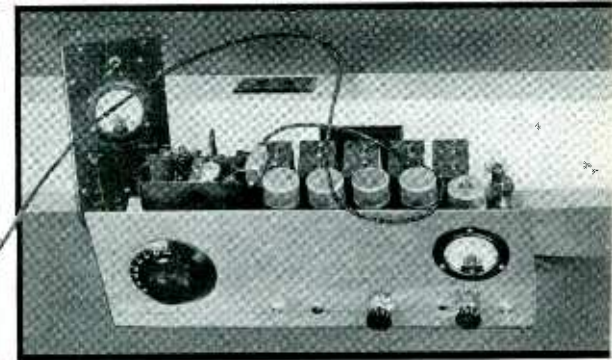
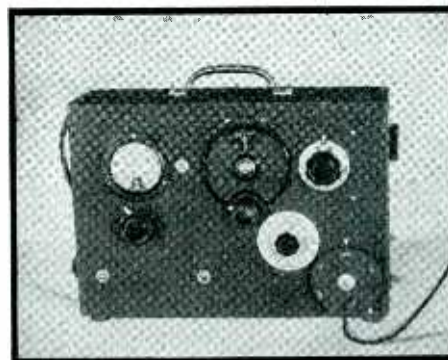

ought to be nearly flat. The trouble turns out to be mostly in the ground lead, for when this is shorted out, by moving the receiver until its chassis contacts the signal generator case, the largest bumps disappear and the curves B and B' are obtained. However, this is still not the correct result, for when the leads are reduced to about one half-inch in length, by dint of great effort, the curves C and C' are obtained. These are proved to be correct when further effort at shortening and rearranging the leads fails to produce any appreciable change.

In this and many similar tests the ground lead was the worst offender, since it put entirely unexplainable bumps and holes in the curves. The high lead was bad enough, but at least it behaved according to reasonable theory, while the ground lead

apparently made its own rules. There seemed to be unpredictable resonances in the complex circuit made up of the generator, receiver, their capacitances to ground, the inductances of the leads, the power supply cords, and the wiring under the test bench. Measurements could never be relied upon or repeated until the ground lead was eliminated and the receiver chassis brought to the same potential as the case of the generator. However it was apparent that until this limitation could be overcome, and the necessity for propping apparatus up at crazy angles to shorten leads could be eliminated, the whole thing was fantastic and impossible from a commercial standpoint.

The use of a properly terminated transmission line on the output of the generator finally solved the prob-

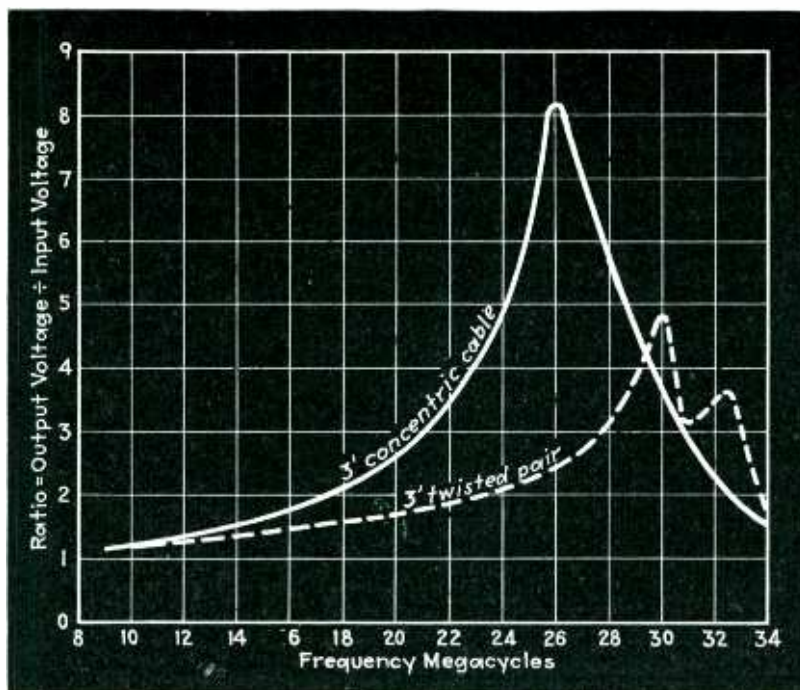

Fig. 1—Effect of leads on gain measurements

lem. A three-foot section of flexible concentric line was used, its outer end terminated in a resistor of the proper value, and the whole output system arranged so that the indicated microvoltage appeared across the resistor. This resistor was housed in a very small box which also served as a mounting for the output binding posts, the whole assembly being small enough to permit its insertion into almost any part of a receiver into which the voltage was to be introduced. In many cases it was possible to clamp the "ground" terminal directly onto some portion of the receiver shielding, eliminating the ground lead entirely. Now, obtaining leads short enough to eliminate resonances became easy, instead of calling for ingenuity and gymnastic ability of a high order.

The use of the transmission line placed unusual requirements upon the remainder of the output (attenuator) system. This was finally worked out to provide proper attenuation, to terminate the line properly under all conditions and all settings of controls, to compensate for the shunting effect of the line upon the attenuator, and to correct for the transmission loss of the line so that the correct voltage would actually appear at the end of the line. There was no more trouble with unexplainable bumps in the curves, measurements could be made and repeated

without difficulty, and work on receivers in the ultra-high-frequency region became almost as easy and reliable as in the now familiar lower-frequency bands.

The next step was to employ the new transmission line output system in a generator which would embody those features of ease of control and convenience of operation which we have become accustomed to expect of modern generators. Line operation, output metering, direct-reading output controls, were all easy enough. Self-contained coils for band-switching looked harder, and the undesirable plug-in coil seemed inevitable. But a trial oscillator built with the coils mounted in a rotating drum proved unexpectedly successful and was adopted. The use of the acorn triode tube, small components, and short leads gave satisfactory operation at frequencies up to 100 mc. and fairly good results up to 150 mc. At this point, however, practically all of the inductance is in the leads and contacts and very little is left for the coil itself, so that 150 mc. is about the practical limit for this type of construction. Frequency modulation was held down to a point where the modulated signal could be received on a superheterodyne of the selective communications type with out difficulty or mushiness in the audio tone.

The voltmeter which indicates the

output of the oscillator is of the diode type, provided with a bucking circuit to allow compensation for varying cathode temperatures due to varying line voltage. This meter indicates the voltage set up by the oscillator across a single turn of heavy brass strip which forms the first, continuously variable, portion of the attenuator system. Provision is made to adjust the output of the oscillator to permit bringing this voltage to the correct value. Any desired portion of the voltage existing across the single turn is picked up by a moving arm contact, the position of the arm being shown on a panel control calibrated directly in microvolts output. This, together with the customary multi-position ladder type resistance attenuator network permits the customary values of output microvoltage to be obtained. The inductive type of potentiometer has proven reliable in service and should give longer life than the resistive type, although the chief reason for abandoning the resistive potentiometer was the fact that no design suitable for use at high frequencies was available.

On page 17 is shown a preliminary model of a 20 to 100 mc. generator connected to a receiver for measuring sensitivity showing the manner in which the transmission line permits the output voltage to be inserted into the receiver. The ground terminal of the output box is clamped on the shielding of the receiver, while the high lead is only about an inch long.

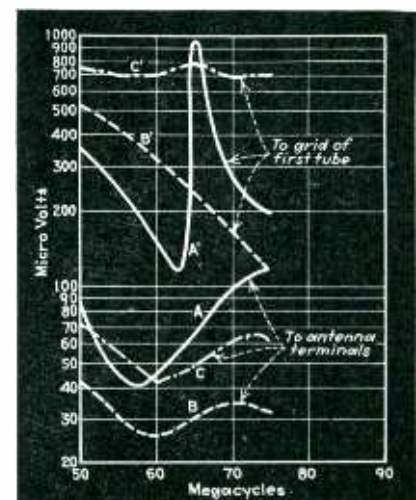
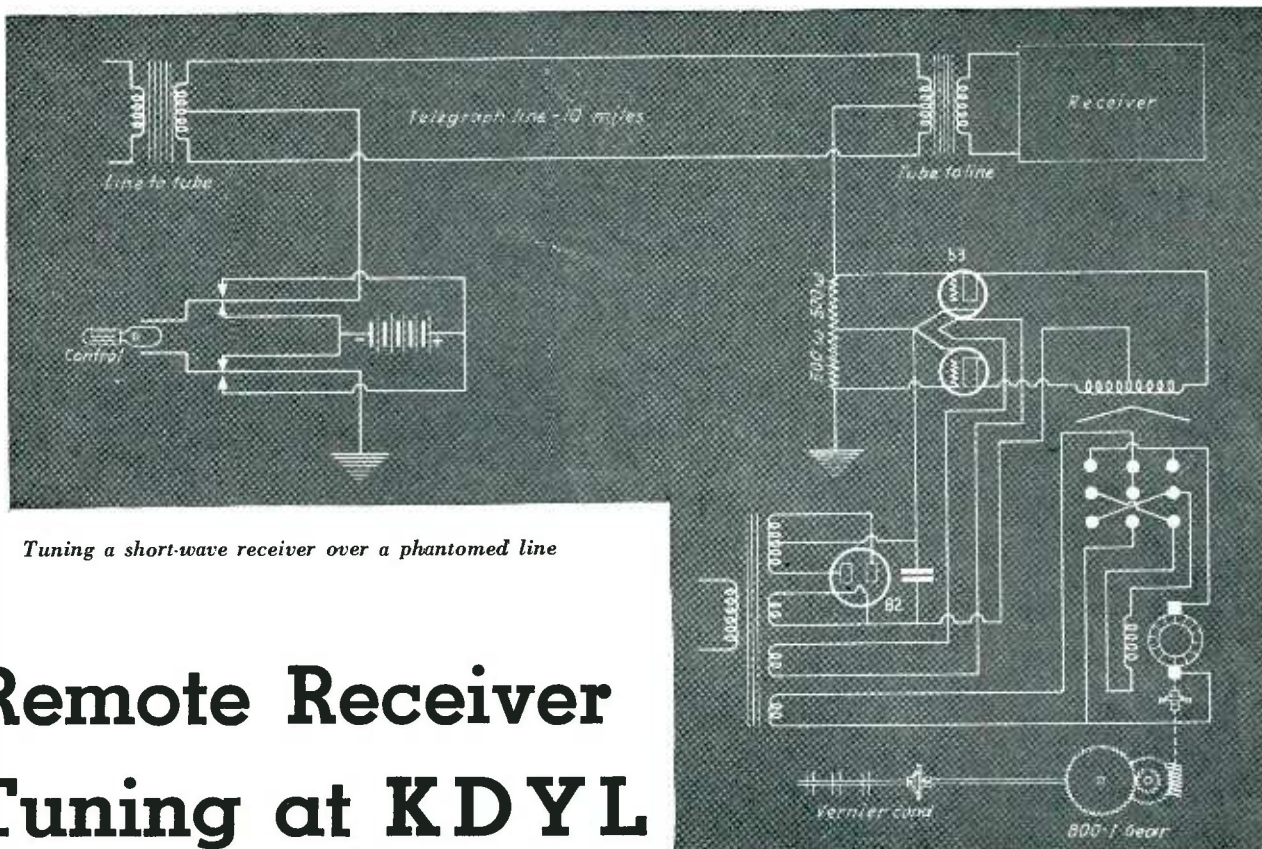

Fig. 2—Measurements made with setup described



Tuning a short-wave receiver over a phantomed line

Remote Receiver Tuning at KDYL

John M. Baldwin describes a solution to a short-wave press service problem

STATION KDYL, subscribing to one of the short wave press services, has found it necessary to install the receiver at the transmitting terminal, to obtain more reliable reception than would be obtained at the studios, located in a center of high noise level. The output of the receiving equipment is transmitted to the studios through a telephone line, where it is copied by an operator. Using this system, two men are normally required—one to keep the receiver in tune and the other to copy. In practice, frequent retuning of the receiver is necessary during a news transmission, and the operator at the terminal has a double duty to perform—to watch the press receiver and monitor the broadcast program. This has its obvious disadvantages, and so a remote control system has been designed to enable the copyist to tune the receiver from the studios. Inasmuch as there are a few novel features in this control system, a

description is given below, so that other stations confronted with the same problem may avail themselves of it.

An inspection of the circuit diagram, shows the equipment to be merely a vacuum tube polarized relay, actuated by changes in grid bias, controlled from the studio news room and in turn operating a specially constructed electromagnetic switch, which controls the starting, stopping and direction of rotation of a small commutator type motor, driving a vernier condenser through an 800 to 1 reduction gear. This vernier condenser is a three gang unit and is connected in parallel with the three gang tuning condenser in the receiver, which tunes the first r-f, detector, and oscillator circuits respectively, in an ACR 136 receiver.

At the studio end of the line, a small lever type switch is so connected that in the center position there is no potential difference between

the phantomed line and ground. In the other two positions of the switch, however, the phantomed line is biased either positive or negative in respect to ground, and controls the plate currents of the two sections of the type 53 double triode control tube. The switch itself is a WE control key, such as used for ringer service on telephone switchboards, and connected as shown. In the normal (no bias) position of the control key, the two plate circuits of the 53 control tube pass about 20 ma. When the switch is thrown in either position however, one grid goes positive and the other negative. This unbalances the plate currents so that one plate draws 100 ma. and the other drops to zero. This causes the electromagnetic switch to throw off center position, closing the motor start and field polarity contacts and causing the vernier condenser to rotate slowly as long as the control switch is held closed.

The windings of the electromagnetic switch consist of 6000 turns each of number 34 enameled wire. Although this size wire is not rated to carry 100 ma. continuously without heating, the intermittent use to which it is put prevents any diffi-

[Continued on page 31]

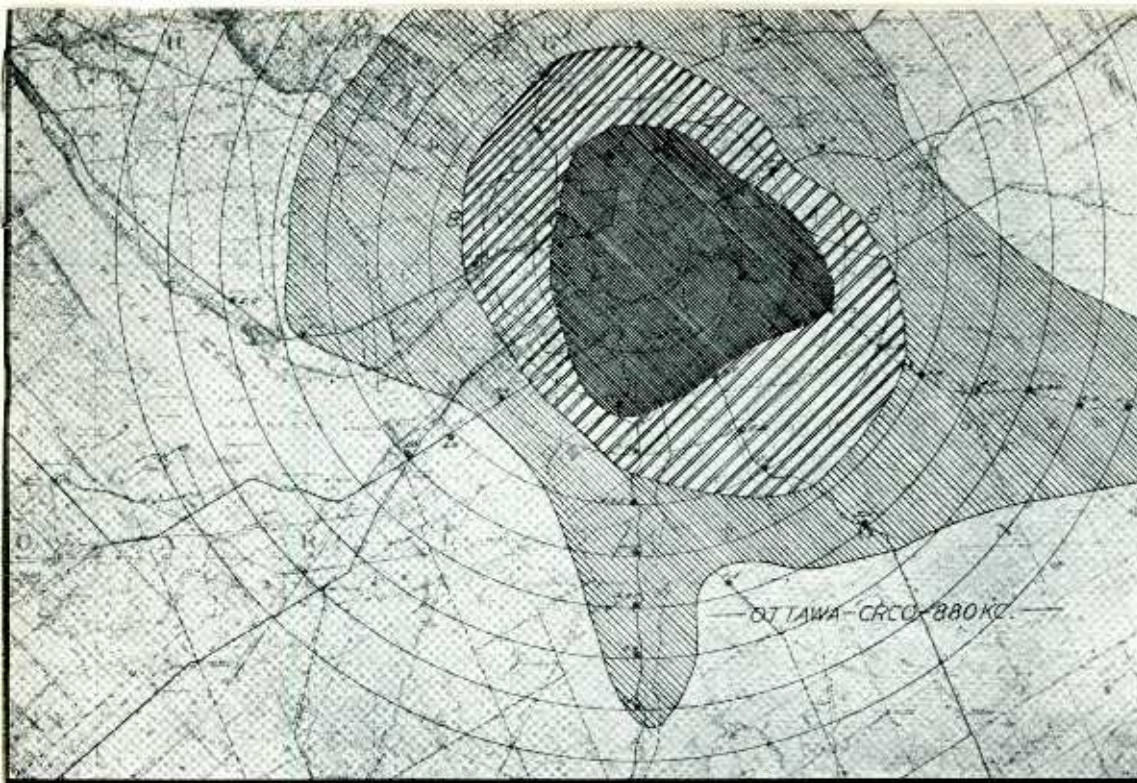

By H. M. SMITH
*Engineering Division,
 Canadian Radio Broadcasting
 Commission*

Map of boundaries of various grades of broadcast service

THE development of any engineering activity or process is characterized by increasingly rigorous test and measurement technique. Indeed, tests and measurements occupy a very prominent part in soundly establishing the application of any new principle. This is justified, not only in widening existing knowledge regarding a particular activity or process, but also economically in minimizing empirical factors in application, with the general consequence of increased yield or efficiency per unit cost. As application increases, refinement of processes and methods occurs, requiring more and more precise production control.

Radio is no exception to this general rule, and its increasing economic and social importance has brought with it a need for more precise information on its abilities and limitations. The need is further emphasized where a specialized technical service is intimately associated with the lay public as in the case of broadcasting. Varying opinions are bound to exist with more or less knowledge of the technical considerations involved. Such opinions can only be justified by facts, and unfortunately the facts are all too frequently rather obscure. It is the purpose of this article to discuss some general considerations involved in one of the less well known, but

basically important phases of radio transmission—the measurement of the electro-magnetic field of a radio transmitting station. Its significance is appreciated with the realization that it is the strength of this field which determines whether or not the transmitting station can be heard at any given receiving point. In other words, the strength of this field determines the area throughout which a given radio station can render service. The discussion in this paper will be confined to broadcasting stations and frequencies. The same general considerations apply to the other radio services, though the requirements and methods may vary greatly.

Theoretical investigation indicates that the field intensity of any radio station, expressed in terms of the voltage induced in a conductor exposed to that field, is given by the relation,

$$E = \frac{KHI}{\lambda d} \times S$$

where E = volts induced per meter of receiving conductor; usually known as "field intensity"

K = a number dependent on HI/λ

H = transmitting antenna height

I = transmitting antenna current

λ = transmitter wave length.

d = distance from transmitter to receiving point

S = a reduction factor known as the "attenuation factor." S is always less than 1.

A rigorous analysis of antenna radiation indicates the presence of another field, known as the "induction field." It can be shown to vary as 1/d² and is 90 degrees out of phase with the field under consideration. Its effect is not significant at distances greater than 4 or 5 wave lengths from the transmitting antenna, and it will not be considered further here.

As shown above, the relation between field intensity and antenna height, current, wave length and distance is a simple one. The term HI/λ may be replaced by k²√w representing the radiated component of the antenna power input.

The factor S, however, cannot be passed over so lightly. It is an extremely complex function of wave length, distance, ground conductivity and earth's dielectric constant. Attempts have been made to evaluate it by several investigators, both theoretically and empirically, with varying degrees of success. Any such process, of necessity, must be of limited value for the evaluation of S can only be accurate over flat terrain having constant ground conductivity and this condition is extremely rare in nature. Irregularities such as hills, cities or towns, and variations of ground conductivity with strata

Field Strength Measurements

The days in which stations are rated by antenna power as a measure of their effectiveness are, fortunately, coming to a close. Exact measurements prove to be better criteria of performance than argument

of various depths all operate to defeat even approximate calculation of S . It is obvious that S must be determined precisely if there is to be any accurate prediction of radio coverage in a given area.

Measurement of field strength permits the S for any territory to be determined readily. If measurements are made at intervals along a radial line from the transmitter the data may be plotted in the form E_d vs. d . It is apparent, from the relation given, that if S were equal to unity the product $E \times d$ would be a constant (for a given frequency and antenna power). For constant frequency and ground conductivity it can be shown that S is a variable function of d , decreasing as d increases.^{1,2} In addition, hills and other changes in topography and subsoil conditions further contribute to variations in S so that its value, always less than unity, will vary widely along one radial and, very frequently, in different directions from the transmitter.

With the measurement data plotted in the form noted above, the value of S in any region may be determined, and when broken down yields the value of the ground conductivity in that region. Once the ground conductivity is known, fairly simple calculations permit the prediction, with fair accuracy, of field strength from a station of any power and frequency at any point within the area investigated.

Measurement Avoids Conjecture

Applications of the general problem, as outlined above, are many and varied. It is readily apparent that with measured values available, there is no valid ground for conjecture regarding the grade of service rendered by a station in any particular area. This usually requires a

complete survey of the area covered by a station. The data is plotted on a map and equal signal contours drawn to indicate the boundaries of the various classes of service rendered by that station; these, of necessity, will vary widely. Examples are shown above. For example, a field intensity which would be unsuitable in the business section of a city, due to artificial interference produced by elevators, street cars, defective electric signs, etc., might be capable of rendering good service over many square miles of rural area where the artificial noise level is very low.

Due to the necessity of allocating a large number of stations to comparatively few channels, interference is often a problem. The Canadian Radio Commission assesses each Canadian station with a fair service area. This will

vary with the station's power and efficiency and is determined by field strength measurements. An endeavour is made to protect each station against radio interference within its fair service area. The Commission has had recourse to field strength measurements on many occasions to determine whether or not such interference occurred within the fair service area of the plaintiff.

A transmitting antenna propagates a field in practically all directions in a vertical plane above ground. The component of the transmitted field included in the angle formed by the earth's surface and a line 10 degrees above the horizon, with the transmitting antenna as origin, will be designated, for this discussion, as "ground wave"; the remainder, propagated in directions making an angle from 10 to 90 degrees above the horizon, will be termed "high angle radiation" or

Portable field strength measuring equipment

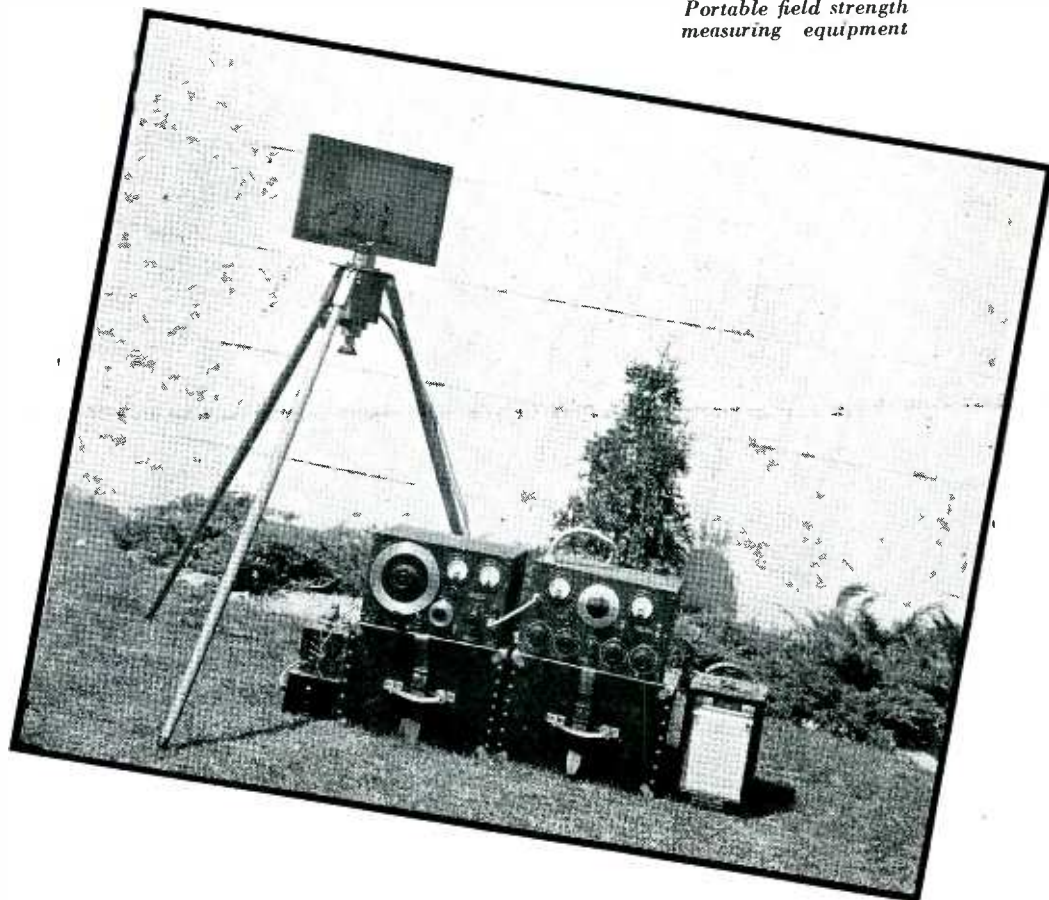

"sky wave." It is apparent that the ground wave is most useful in areas adjacent to the station. This ground wave, however, is subject to rapid attenuation, due to the factor S discussed above and the fact that even without attenuation the field would decrease inversely with the distance from the station. At some distance then, its value becomes so low as to be of no further use in producing suitable reception because of artificial noise level, limitations in receiver sensitivity, or both. Let us call this limiting distance d^1 miles.

The high angle radiation is almost completely absorbed in daylight; this does not occur during darkness, and at broadcast wave lengths it is effectively reflected from the ionosphere located some 60 to 70 miles above the earth's surface. Depending upon the angle of propagation this reflected component returns to the earth at varying distances from the transmitter. The combined action of the ground and sky wave components then produces the voltage in the receiving antenna. If the sky wave component is of the same order of magnitude as the ground wave, fading of various types usually exists, due to amplitude and phase variations of the reflected component together with polarization. There is always some distance d^{11} miles from the transmitter at which these reflected components become appreciable as compared with the amplitude of the ground wave at that point and where amplitude and phase variations of the resultant defeat the usefulness of automatic volume control systems in the receiver. This region

is known as the "zone of first fading."

If d^{11} is greater than d^1 , as is frequently the case with stations of low power, fading becomes a minor problem within the fair service area of the station. If, however, d^1 is greater than d^{11} the night service area of the station becomes less than the day area. Since broadcasting is useful to a greater number of listeners during the evening hours than at any other time of the day, this point becomes of serious importance in the case of stations of medium and high power. The sky wave and ground wave components are both increased in the same proportion as the transmitter power is increased; the zone of first fading is therefore independent of transmitting power and power increases alone would appear to present no proper economic solution to the problem.

Chart below shows the night field strength of a station measured at a point 150 miles from the station. A daytime measurement would indicate a steady field strength showing the absence of reflected components. The night measurements show the wide variations of field intensity which may be encountered. Recordings of this type are useful from several practical standpoints. Analysis of the record shows the actual time, during a given period of recording, in which the signal exceeds certain specified values; in this way the exact amount of valid interference is determined for a given set of conditions, throwing the light of fact upon what may or may not be reasonable claims. Another obvious

use is to show to what degree automatic volume control in commercial receivers will permit a fading program to render useful service.

The proportion of ground wave to sky wave can be controlled to some extent by the physical height of a transmitting antenna for a given wave length. The costs of antenna structures depend on a factor which varies roughly between the square and the cube of the height so it is readily apparent that the economics of such moves warrant reasonably close consideration, particularly since the increase in service area and the reduction in fading which can be effected in this manner are limited.

This immediately suggests that transmitter efficiency, or more properly antenna efficiency, must contain, in addition to factors determining its electrical efficiency, a term which specifies the degree to which high angle radiation is suppressed. Any expression of this nature is extremely involved and radiation theory is not yet sufficiently clarified to permit such an expression to be generally useful. One can, however, calculate with reasonable accuracy the field strength which would be obtained from a perfect antenna with a given power at any point. From the measured value of field strength at such a point, together with a knowledge of S , a measure of antenna efficiency in terms of the ideal can be obtained. This is very useful in practice and provides an excellent index regarding the degree of usefulness of any station in terms of the best performance possible for a given power and wave length.

Field Measurements

It hardly needs to be pointed out that a survey of a given area, using a low power portable transmitter, supplies very valuable information (which could not otherwise be obtained) for use in the most efficient location of a new station. In this case S is evaluated, as discussed previously, to provide the range of ground conductivities existing within the region under consideration. From this the best site, as determined by coverage vs. economics, may be obtained. Experience has indicated that it is unwise to take liberties in predicting coverage of a projected station beyond the region investi-

[Continued on page 38]

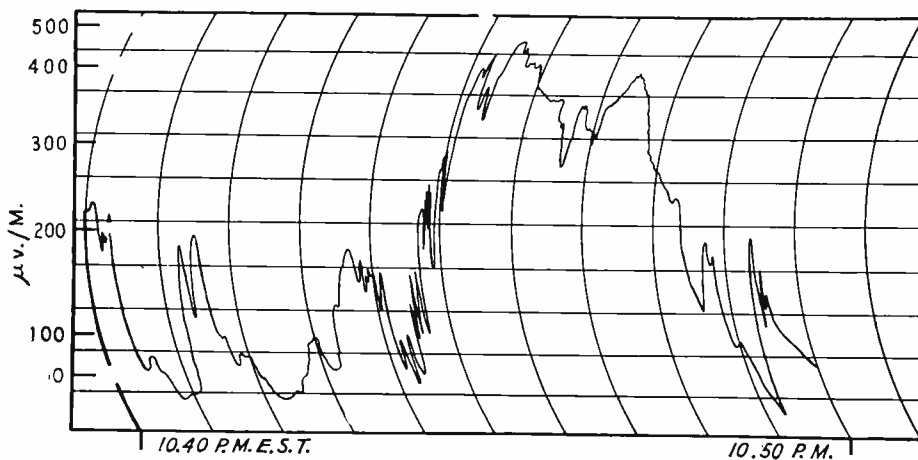

Night field strength 150 miles from station

Modulation Measurement

Which to use—peak voltmeter, r.m.s. meter, or average-value meter? A diode rectifier followed by a linear d-c amplifier is the solution offered in this design article

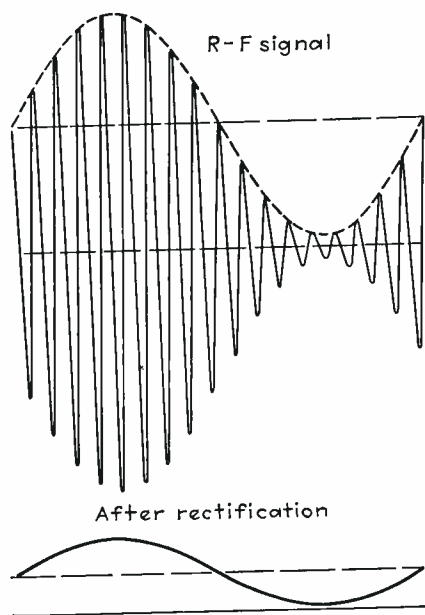

Fig. 1.—Relation between modulated and rectified currents

IN making quantitative measurements with modulated r-f currents, the degree of modulation, usually expressed in per cent of the average r-f amplitude, is of tantamount importance with the r-f amplitude itself.

Modulation percentage is determined by subjecting a portion of the signal to linear rectification, and then comparing the magnitudes of the d-c and a-c components of the current developed by the rectification. The d-c component is proportional to the average r-f amplitude. Superimposed on this is an a-c component having the same wave form as the imaginary line connecting successive peaks of like sign of the impressed r. f., and bearing the same amplitude relation to the d-c component as the imaginary line bears to the average r-f amplitude. This is illustrated in Fig. 1. The per cent-modulation meter must measure the minimum-peak, average, and maximum-peak values of the current passed by the rectifier. Knowing these values, the modulation per cent is given by:

$$\% \text{ modulation} = \frac{I_{max} - I_{min}}{2 \times I_{av}} \times 100 \quad (1)$$

But sometimes the modulation percentage as thus determined is not the most valid coefficient. This is the case, for instance, in production gain-testing of radio receivers—and in most laboratory tests of similar nature—because almost invariably in this work output meters are used which indicate more nearly r. m. s. than peak amplitudes. When an r. m. s. output meter is used and the signal modulation is other than sine wave shape, an error is introduced if the modulation percentage is determined by the standard method outlined above, that is, with a peak meter. Substituting an r. m. s. meter for the peak meter, the “effective” modulation per cent becomes:

$$\% \text{ modulation} = \frac{1.41 I_{a-c}}{I_{d-c}} \times 100 \quad (2)$$

Rectifier type meters are widely used for evaluating radio receiver output. The indication of this type of meter is most nearly proportional to the average current, but the calibration is in terms of r.m.s. of current of sine wave form. Substituting a rectifier type meter in the circuit of Fig. 2 and again obtaining the modulation percentage from Eq. (2), we find that for a departure from sine wave modulation a different percentage will be indicated than with either a peak or r.m.s. meter. The percentage of modulation indicated by peak, r.m.s., and rectifier type meters on signals modulated as shown in Fig. 3 are tabulated below. The figures are approximate, and neglect the effects of frequency discrimination and non-linear rectification in the rectifier type meter. Greatly exaggerated

By C. G. SERIGHT

Radio Products Company

wave types were chosen for better illustration.

The inference to be drawn from the foregoing discussion is that except for such uses as determining over-modulation, an r. m. s. or recti-

Measured by	Sinusoid	Peaked wave	Obtuse wave
Peak meter...	100%	100%	100%
R.M.S. meter...	100%	71%	110%
Rectifier meter...	100%	61%	112%

fier type meter will frequently give a more legitimate indication of modulation per cent than can be obtained with a peak meter. It must be understood, however, that the writer does not overestimate the importance of the point. The modulation of signals used in measurements usually approaches sine wave form, in which case all of the meter types discussed give equivalent indications.

Furthermore, the error in measurement of modulation per cent is in nearly all cases overshadowed by greater errors in measurement of small signal voltages. On the other hand, there are probably

cases in which precautions need to be taken to insure the *most valid* determination of modulation percentage.

The circuit of Fig. 2 would be suitable only for high energy sources, such as transmitters. Even with the substitution of a rectifier type a-c meter, the load imposed on the measured circuit would in many instances be greater than could be tolerated. An r-f amplifier between the measured and measuring circuits would introduce a probability of large errors. The alternative is a linear d-c amplifier following the rectifier. A

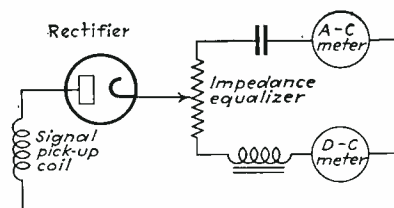

Fig. 2.—High energy meter.

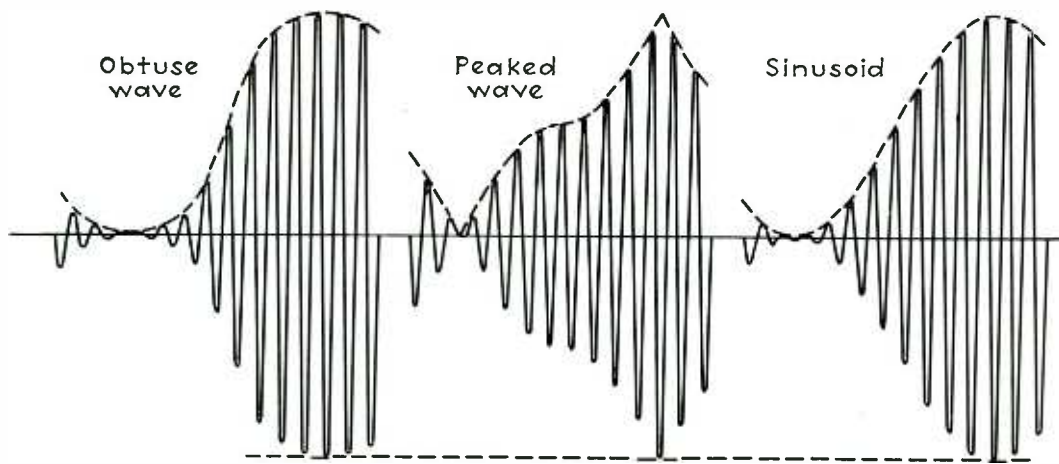

Fig. 3.—Types of waveforms encountered

circuit worked out by the writer in connection with the development of a production gain-testing system is diagrammed in Fig. 4.

The diodes of an 85 tube are coupled to the circuit carrying the signal to be analyzed. A portion of the rectified voltage is impressed on the grid. The plate circuit contains the indicating meters, a ballast resistance, and a filter to separate the a-c and d-c components of the plate current. A rheostat and bucking battery around the d-c meter enable setting its needle to the end of the scale when the r-f input is reduced to zero. The a-c meter has a range of 1 ma., r. m. s. If the input is increased from nil by an amount sufficient to produce an increment of 1.4 ma. in the d-c meter reading, and the a-c meter then reads full scale, the indication is 100% modulation. The a-c meter has a 100 divi-

sion scale, and correspondingly indicates fractional modulation directly in per cent.

Inasmuch as rectifier meters have a non-uniformly-divided scale, and this departure from linearity is a function of the resistance in series with the meter, the a-c meter should be equipped with a scale compensated for a multiplier approximately equal in resistance to the total plate circuit a-c impedance. A 100 v. scale was used in the writer's meter, but a 25 or 50 v. scale would have been slightly more accurate in measurement of low percentages. Also, the a-c meter scale could be calibrated up to 125 or 150% (and a corresponding compensation made in the d-c meter increment) so as to read "effective" modulation in excess of 100%.

The load imposed on the measured circuit is inversely proportional to

the resistance in the diode circuit. A high resistance potentiometer is therefore to be preferred. An r-f filter is advisable between this potentiometer and the grid. The capacitance of this filter, plus that of the diode input condenser, must be low enough in relation to the potentiometer resistance that the modulation component of the rectified signal is not attenuated.

The plate supply potential need be only sufficient to accommodate a plate current change of slightly more than twice the required d-c increment on the straight portion of the Ec-Ib curve. 200 volts is a satisfactory value.

For accurate measurement, a correction must be made in the d-c incremental reading. To make this calibration, the d-c meter is adjusted to the end of the scale by means of the bucking circuit. Then a small d-c voltage is introduced in series with the grid bias battery. A smaller sine wave a-c potential of accurately known magnitude is also connected in series in the grid circuit. The a-c potential is adjusted to a value that gives some convenient reading, say 50, on the plate a-c meter. The d-c voltage is then adjusted to:

$$E_{dc} = \frac{1.41 \times \text{a-c grid volts (r.m.s.)}}{\% \text{ reading of plate a-c meter}} \quad (3)$$

whereupon the d-c increment is read. This increment is subsequently used in lieu of 1.4 ma. in per cent measurements.

Push-button switches as shown add greatly to the convenience of

[Continued on page 38]

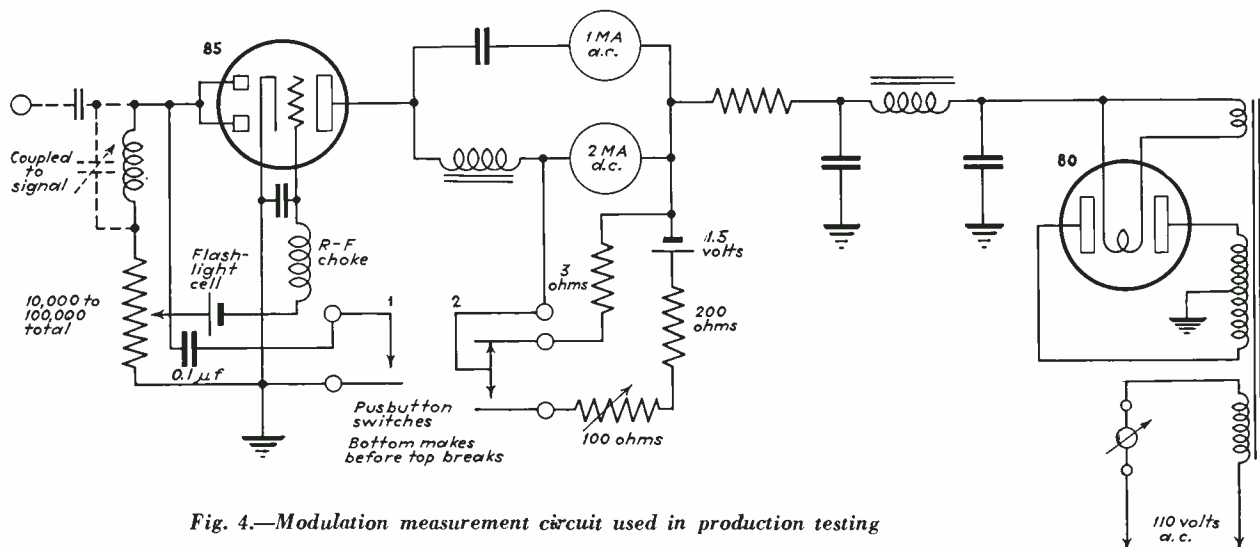

Fig. 4.—Modulation measurement circuit used in production testing

Mean Level Determination

GEORGE H. LOGAN

Sound Department, M. G. M. Studio
Culver City, California

WHEN the relative energy output of a source (such as a speaker system, for example) is obtained on a high speed level recorder, the chart in general appears as standing waves which vary in amplitude about some unknown mean energy level. Figure 1 represents such a chart, with decibel ordinates, and frequency abscissae. To study the system characteristic, it is desirable to plot the mean level in decibels against log frequency.

It must be remembered that the energy level, when recorded in decibels, does not vary arithmetically but changes logarithmically. The correct procedure, then, is to read from the chart the maximum and minimum decibel values for a particular frequency, convert these to corresponding power ratios, average the power ratios, and finally convert this average power ratio to decibels. In this manner is found the true average level for a specific frequency. Finding a number of such points throughout the frequency range, and connecting them with a smooth curve produces the true mean level curve.

In deriving the mean level equation, let D_1 and D_2 be the maximum and minimum recorded levels at a given frequency.

$$D = 10 \log_{10} PR \text{ or } PR = (10)^{\frac{D}{10}}$$

At the extremes D_1 and D_2 —

$$PR_1 = (10)^{\frac{D_1}{10}}; PR_2 = (10)^{\frac{D_2}{10}}$$

Hence the average power ratio is—

$$PR_{av} = \frac{10^{\frac{D_1}{10}} + 10^{\frac{D_2}{10}}}{2}$$

Fig. 1—Response curve for demonstrating average level determination

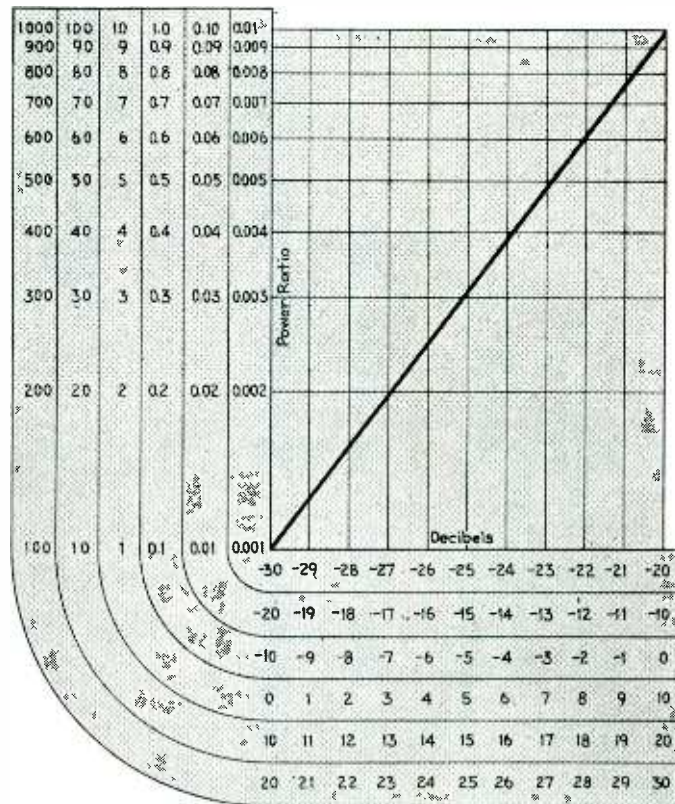
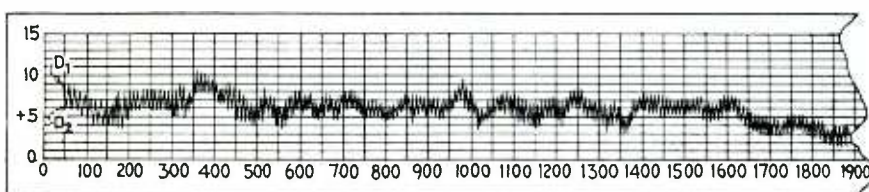

Fig. 2—Unusual form of power ratio-decibel chart from which values for formulas may be secured

To convert to average decibel values—

$$\begin{aligned} D_{av} &= 10 \log_{10} PR_{av} \\ &= 10 \log_{10} \left[\frac{10^{\frac{D_1}{10}} + 10^{\frac{D_2}{10}}}{2} \right] \\ &= 10 \log_{10} \left[10^{\frac{D_1}{10}} + 10^{\frac{D_2}{10}} \right] - 10 \log_{10} 2 \\ &= 10 \log_{10} \left[\text{antilog} \frac{D_1}{10} + \text{antilog} \frac{D_2}{10} \right] - 3.010 \end{aligned}$$

Therefore, to compute the mean decibel level at a certain frequency, the extremes D_1 and D_2 are read from the chart, substituted above, and the equation solved for D_{av} .

To illustrate use of the formula, solution for mean level at 50 cycles is given.

Reading D_1 and D_2 , Figure 1—

$$D_1 = 9 \quad D_2 = 6$$

$$\begin{aligned} D_{av} &= 10 \log_{10} \left[\text{antilog} \frac{9}{10} + \text{antilog} \frac{6}{10} \right] - 3.010 \\ &= 10 \log_{10} [7.943 + 3.981] - 3.010 \\ &= 10 \log_{10} [11.924] - 3.010 \\ &= 10 [1.0764] - 3.010 \\ &= 10.764 - 3.010 \\ &= 7.754 \text{ decibels} \end{aligned}$$

In practice it will be found satisfactory and appreciably faster to obtain D_{av} using Figure 2. Taking D_1 and D_2 at 50 cycles, Figure 1—

$$D_1 = 9 \text{ from Fig. 2, } PR_1 = 7.7$$

$$D_2 = 6 \text{ from Fig. 2, } PR_2 = 3.9$$

$$PR_{av} = \frac{7.7 + 3.9}{2} = 5.3$$

from Fig. 2, $D_{av} = 7.8$ decibels

By DANIEL E. NOBLE
 Assistant Professor of Engineering
 Connecticut State College

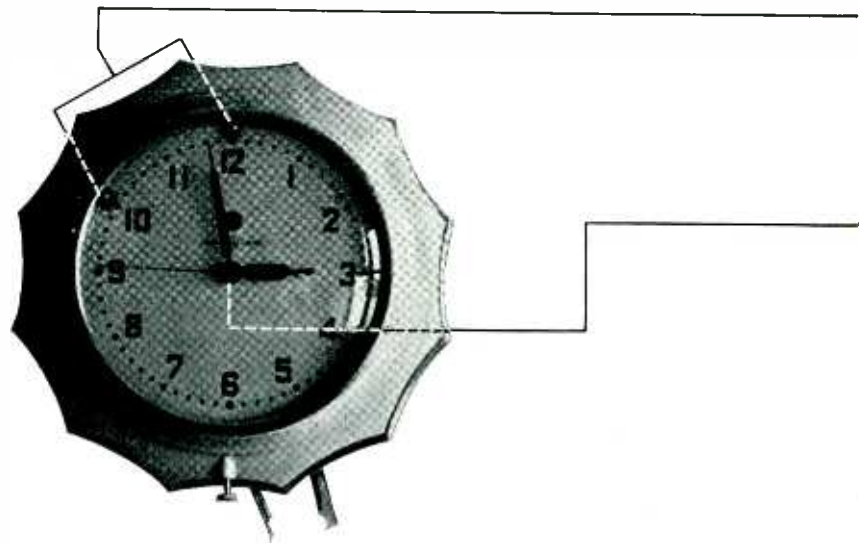

Limited Impulse & Delay Relays

Many circuits using tubes for relays have been devised; Professor Noble contributes his share in a class room bell timer, and a photographic printing time control. They operate from a.c.

THE widely used electronic relays are either designed for d-c operation or for a-c use with a rectifier system in the unit. While no claims of startling originality are made by the author the relays described below operate on a.c. without a rectifier system and offer a simplicity of design which will appeal to the engineer or scientist concerned with control problems.

The limited impulse relay so-called

because the impulse may be limited to any fraction of the original contact time, will find many uses in process timing. In the author's laboratory, two such units are in use. One is connected to an electric clock, as shown above, for the purpose of timing classes. When the hour hand brushes the insulated contact at ten minutes to the hour, the relay closes to ring the class-ending bell and on the hour the relay again

closes to ring the class-starting bell. The electron relay has these characteristics:

1. The contact sparking current is negligible since the contacts operate in series with a half million ohm resistor.
2. The ringing time of the bells is limited (in this case to three seconds) to a predetermined impulse. The slowly moving minute hand may move errati-

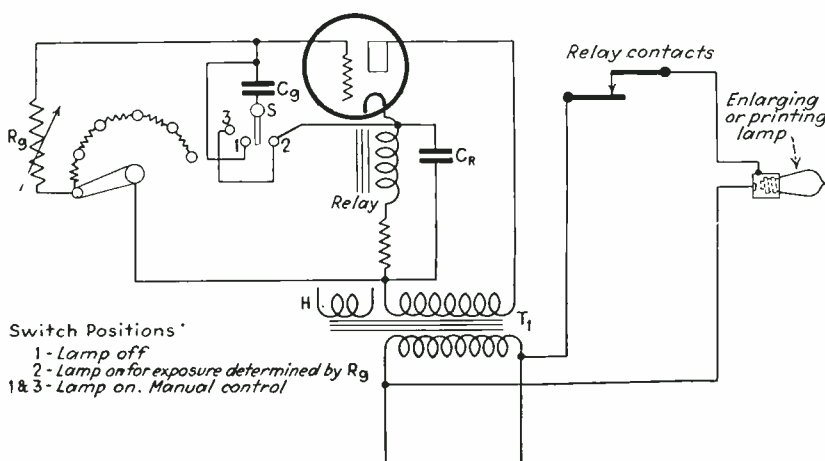

2 Photographic printing light control

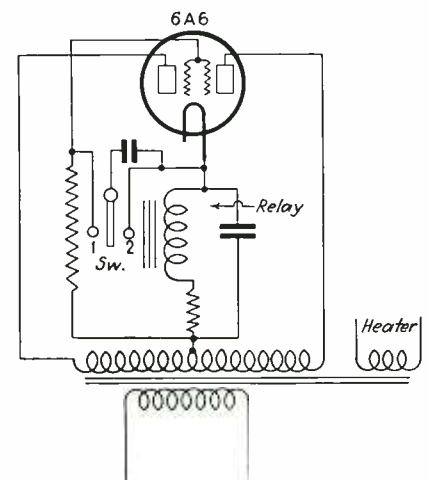

3 Twin triode limited impulse circuit

1 Limited ring impulse clock timer

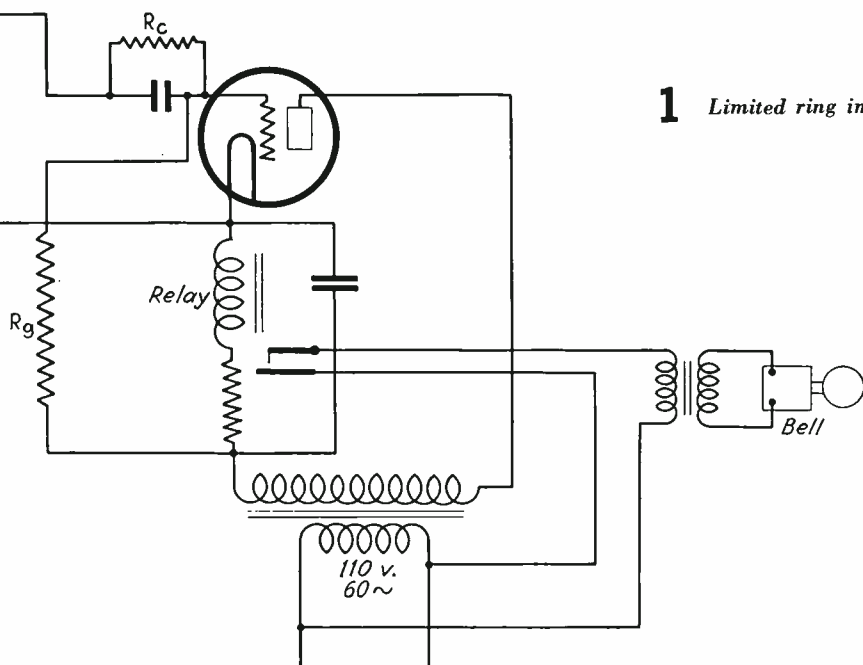

cally over the contact for a half minute or more without affecting the bells beyond the length of the original pulse.

of duplicate prints are to be made.

In the second unit in the laboratory, the resistance R_g is a variable unit equipped with a dial calibrated in seconds (Fig. 2). The lamp circuit of either a photograph contact printer or enlarger is connected through the relay circuit. Used in this way, the device is a magnificent saver of time and patience. The photographer places his paper in position, sets the dial for proper exposure and throws the switch. The relay then turns on the light for the exposure and automatically turns it off at the end of the predetermined exposure period. The unit is especially valuable when a large number

The operation of the limited impulse relay depends upon the well-known condenser charging principle. When switch S (Fig. 2) is thrown to Position 2, the condenser C_g charges through R_g . The charging voltage is the drop across the relay circuit. The grid bias before the switch is thrown is also equal to the voltage across the relay circuit but at the instant the switch makes contact the condenser charging current is a maximum. The grid bias is then equal to the drop across the relay circuit minus the drop across R_g . As the charging of the condenser proceeds, the current through R_g decreases resulting in an increase in the negative grid bias. When the condenser is fully charged, the grid bias is again approximately

equal to the drop across the relay circuit. Therefore, when the switch is closed, the plate current rises to close the relay and then falls to open the relay when the grid condenser has charged sufficiently.

On a d-c supply there are no special problems to be solved for satisfactory operation of the relay. When used with a.c. the design must compensate for the fact that current will flow in the plate circuit of the tube only during positive plate half cycle. Fortunately, a power factor adjustment of the relay circuit can be made which will eliminate entirely the chattering of the relay and the unstable timing. Since the values of R_r and C_r will depend upon the characteristics of the relay, no general values can be assigned but in the unit built by the author C_r was $8 \mu\text{f}$ and R_r , 5,000 ohms for a rugged relay which closed on approximately 10 m. a. For the same unit, R_g equals 250,000 ohms and C_g , $8 \mu\text{f}$ for a three second impulse. The time can be altered several hundred per cent by changing the relay spring tension. This should make it clear that the relay characteristics must be considered together with the product $R_g C_g$ when determining the time factor for the relay.

Where rapid recycling is not required, a resistance of 5 megohms or more may be placed across C_g . For rapid recycling the arrangement shown in Fig. 2 may be used.

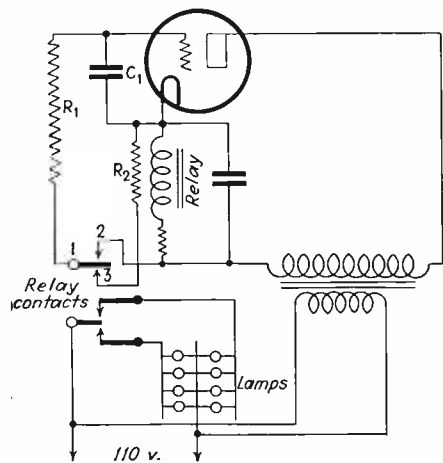

4 Limited impulse relay as flasher control

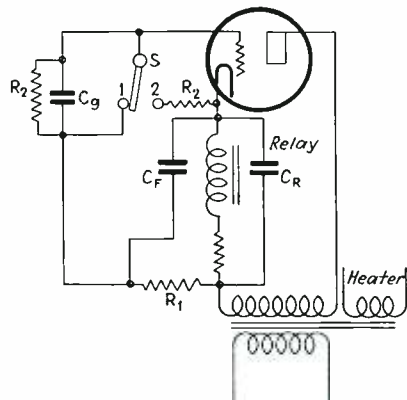

5 Time delay relay using single tube

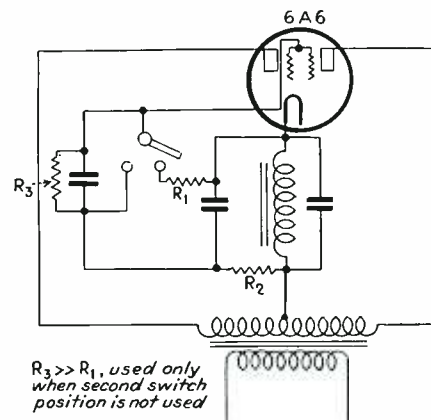

6 Self rectified, time delay relay

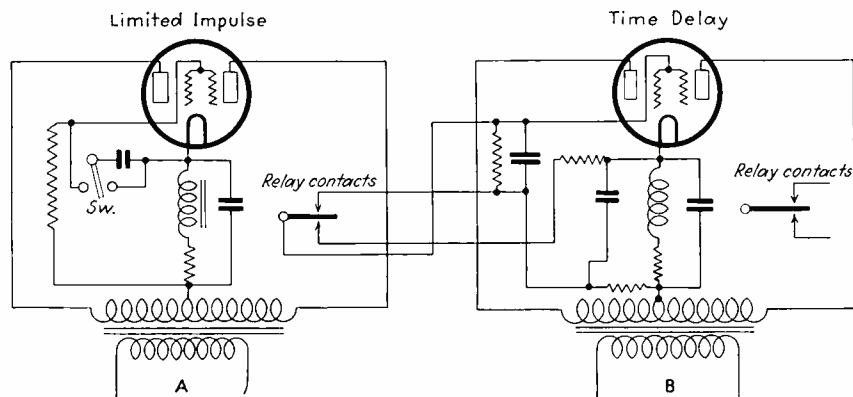

7 Production of impulses above (A) and below (B) certain duration limits

The author has found that the unit is reliable and free from relay chattering. The relay may be adjusted for any impulse period between one-twentieth of a second and three minutes and will maintain the timing of the impulse within five per cent if the supply voltage is constant.

Figure 3 shows the circuit used with a 6A6 twin triode for full-wave self-rectification. This circuit permits the use of a very rugged relay since a large current change may be produced when the switch is moved to Position 1. The elimination of relay chatter is also simplified by the full-wave rectification.

Another use of the limited impulse relay is shown in Fig. 4. A single tube is shown but a 6A6 twin triode would serve as in Fig. 3. The action is as follows:

Lever 1 in Position 3 with zero bias on the grid controls a current through the relay large enough to pull it closed. The lever then contacts 2 and C_1 begins to charge. The grid bias equals the drop across the relay minus the drop across R_1 . As C_1 charges the drop across R_1 decreases and the bias approaches the drop across the relay. This bias is great enough to open the relay and the lever drops back to Position 3. C_1 now discharges through R_1 and R_2 until the bias reduces to a point where the relay will be closed again and the cycle repeated. R_1 and R_2 may be selected to provide a wide range of time on to time off ratios. Extra contacts operate the light circuit. For more complex flasher systems several limited impulse relays may be connected in cascade. Relays which close on currents from 20 to 40 ma. may be used in the twin triode circuit, thus providing

a rugged reliable unit.

The time relay relay will also function properly as a single tube or twin triode tube ac operated circuit.

Figure 5 shows a circuit that has operated very satisfactorily in the author's laboratory. When the switch is placed in Position 2, the condenser C_g begins to charge through R_2 . During the charging process the current through R_2 produces a drop between the cathode and grid negative toward the grid. While the charging continues, this negative grid bias prevents the relay from closing. When the charging process is complete, the grid will be zero in respect to the cathode and the relay will close. By adjusting the values of R_2 and C_g the delay can be varied from a fraction of a second to several minutes. R_1 and C_f are essential to the operation of the circuit. Their function is to filter the fluctuations from the charging voltage. Without the filter the ripple voltage will pass through C_g to produce a continuous fluctuating bias on the grid resulting in no time delay action. Again, the twin triode 6A6 circuit shown in Fig. 6 is somewhat more reliable. In each case the resistance shown across C_g is there to bias the grid negative before the charging operation starts. The magnitude of the resistance across C_g should be much larger than R_2 . Five or ten megohm leaks may be used in the position.

The two relays may be combined into a very interesting circuit which will produce impulses only within certain predetermined limits. Figure 7 shows one version. Two triodes could be used with a single transformer to produce similar results. Since circuit A will operate

for a limited part of the contact time, the upper limit of the impulse can be determined by setting the condenser and resistor values of A. B will not respond to impulses unless they are of longer duration than a predetermined minimum. Thus, short impulses applied to the switch at A will not operate the relay at B and long impulses will operate B only for a period equal to the difference between the A timing and the B timing. B must always be adjusted to a shorter time than A if any impulses are to be allowed to operate B.

Tolerance Relays

The arrangement shown in Fig. 7 could be used for the automatic sorting or checking of resistors or condensers within set tolerances. Circuit A would then be arranged for the insertion of either a condenser or a resistance into the operating position depending upon which was to be tested. Two B or time delay circuits would be connected to the A circuit. With one adjusted for a required delay and the other adjusted for a slightly shorter delay the circuit would operate in this manner:

If the condensers are to be tested, each condenser will be inserted in the operating position in place of C_1 . The size of the condenser will determine the length of the impulse. If the impulse is too short, neither time delay relay will operate and the condenser is rejected as under capacity. If the condenser capacity is correct, the short delay relay will operate and light a signal light or start an automatic selector, but the second time delay relay will not have time to operate with the limited impulse. If the condenser is oversize, the impulse will be long enough to operate both time delay relays and light a rejection light or start a rejection lever. The tolerance could be set for each size condenser or resistance as closely as desired. The accuracy of the system and all the other systems described is largely a function of design. For extreme accuracy an automatically regulated constant voltage d-c supply should be used instead of a.c. but for many applications the a.c. circuit is sufficiently accurate.

Remote Tuning at KDYL

[Continued from page 19]

culty from this source. The contact points are made of coin silver, and so arranged that a slight wiping action occurs when the contacts close. Ford coil contact points should be even more suitable than coin silver ones, and would make a more lasting job. The contacts are mounted on spring brass arms long enough to insure a good springing action without being too stiff. Close fitting is essential in constructing this relay, as it is the most critical item in the entire assembly. Commercial relays capable of performing the same functions should be easily obtainable, but as the control unit was an experimental one, the expense of specially constructed relays was not felt justifiable.

The motor is a six volt commutator type, originally used on an automobile horn. The field connections were changed from series to shunt, and although the result is a woefully inefficient motor, at least it has a good starting torque and plenty of power. No trouble has been experienced from commutator noise and the motor runs very well on a-c supply. Although the control unit is mounted immediately adjacent to the receiver, no precautions have been necessary to eliminate operating noises, because there just aren't any. All sorts of dire forebodings were felt before actual test of the

equipment, and it was a distinct relief to find that all the anticipated troubles were non-existent.

The gear reduction consists of a combination of worm and ring gears giving a reduction of 800 to 1. This is ample, as the vernier condenser rotates so slowly that the capacity change is small enough to enable close tuning. The output of the gear reduction box is coupled to the condenser with a section of speedometer shaft and two universal joint couplings. No mechanical noise is transmitted to the receiver, and the flexi-

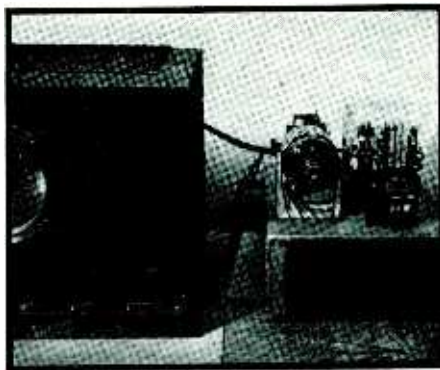

Mechanism as installed at transmitter building where receiver is located

bility of the speedometer shaft enables the control unit to be placed in the most convenient location.

The vernier condenser is a three

gang unit, specially constructed to fit on top of the main tuning gang. The plates are about 1 inch in diameter and spaced about $\frac{1}{4}$ inch. The capacity range is small enough to give a frequency control of about 5000 cycles at 8000 kc. and about 20,000 cycles at 16000 kc. At the beginning of a press schedule, the plates are meshed about $\frac{1}{2}$ of their range, and the controlling operator has a plus or minus variation available by proper manipulation of his control key.

Trouble with leakage ground currents was expected before the apparatus was installed, but to our gratification none was encountered, although no common ground connection was obtainable, other than that furnished by the city wiring system. It was found necessary to use a small r-f choke in the lead from the phantom line transformer to eliminate pickup of the intense r-f field in the vicinity of the transmitter building.

In case any readers of this description wish to build up a control unit similar to this, we will be glad to give further information, provided a stamped envelope is included for reply. This control unit has been in steady operation now for some months, and given completely reliable service. The transmitter operators check the tuning at the beginning of each schedule and from then on give it no further attention. It is indeed a labor-saving device and well worth the trouble of building.

Book Review

The New Acoustics

By N. W. McLACHLAN. *Oxford University Press, New York City. A survey of modern development in acoustical engineering (Five tables, 111 figures. Price \$2.75).*

THIS IS AN INTERESTING ACCOUNT of the contributions of "The New Acoustics." There is a brief review of the background provided for these contributions by the classical theories.

The author considers that the World War, with its need for navigation, submarine and aircraft detection devices, gave the first impetus to recent developments. The second big impetus was given by popular broadcasting.

The evolution of loud speaker, micro-

phones and the electrical phonograph is given in some detail. Although the author's principle contributions have been in the field of loud speakers, the sections covering these devices are not out of proportion to the rest of the work. There are also chapters dealing briefly with telephone receivers, the measurement of frequency, analysis of sounds, behavior of the ear, auditorium acoustics, sound absorption, and one describing a number of deaf aids. The contributions which circuit theory had made to the design of the various devices is discussed.

While an effort has been made to reach "scientists, engineers and general readers", the value of the book to the last of these is restricted by inadequate definitions of many technical

terms and by sketchy descriptions of the principle of operation of the various devices. The book should be of considerable interest to readers of the other two groups who have a scientific background but are not posted on the present state of the acoustic art. The value of the book to the more serious student is limited by the non-mathematical treatment, the paucity of references and by the fact that the author has been handicapped in his choice of illustrative material by an attempt to describe British apparatus. Since most of the contributions in this field have come from the United States and Germany, the author might have made the book of more general interest by making additional references to progress in these countries.

TUBES AT WORK

CONSTRUCTIONAL details of a VT voltmeter using the 954 acorn pentode, a microwave link for WNYC, phototubes for auto-race timing and mine-door control, and a tube for generating kilomegacycles.

A Highly Flexible VT Voltmeter

BY H. G. BOYLE
Delco Radio Division, General Motors

OF THE MANY electronic tools available to the development engineer the vacuum tube voltmeter can be of tremendous value for routine checks. Most of these units as normally constructed are bulky, awkward, and have banks of associated batteries. Usu-



A lamp socket houses the 954

ally the input capacity is high, and changeable, and the shielding is inadequate at high r-f frequencies.

All of these facts assist in producing the attitude that the work can be carried to a tube voltmeter as a last resort. Actually it should be regarded as indispensable as an d-c voltmeter.

The unit described here was developed for general use in measuring gain and selectivity, and, with the assistance of other simple apparatus, the "Q" of coils and the effects of impregnating compounds. It is a very sensitive indicator for use with an absorption type wavemeter.

Advantages of the unit are its complete portability, a-c operation, input capacity of less than five micro microfarads, no load on the circuit, complete shielding, and self check of calibration. The normal range is two volts r-m-s, grid current occurring at five volts input, giving adequate safety range for peak inputs of distorted micro microfarads wave forms.

Where it is desired to extend the range to higher voltages a series of non-inductive resistors may be used to make up multiplier units of five, ten, and fifty times the voltage mentioned. This unit puts a load on the circuit, however, and can be used only where the load is of no moment.

The tube selected for the voltmeter circuit is the "acorn" type 954 because

of its small size and indifference to filament fluctuations. By connecting the plate, screen and suppressor together a hi-mu triode is produced with desirable cut-off characteristics.

The mounting ring of bakelite or insulantite is arranged so that the lugs on the mounting clips are bent down and the whole assembly slipped in a brass lamp socket from which the threaded shell and snap switch have been removed. This is attached to a standard eighteen inch gooseneck and the filament, cathode and plate wires run inside. A rounded "bullet" nose was soldered to a thin brass ring, threaded to fit the open end of the socket and all surplus metal ground away. This results in a completely enclosing shield and has proven adequate for any frequency. In this nose is also mounted a very small switch to short the grid when the instrument is not in use or shunt the grid when used with circuits containing open-circuit direct current voltage.

A small hole in the cap, containing a rubber grommet, allows the grid lead

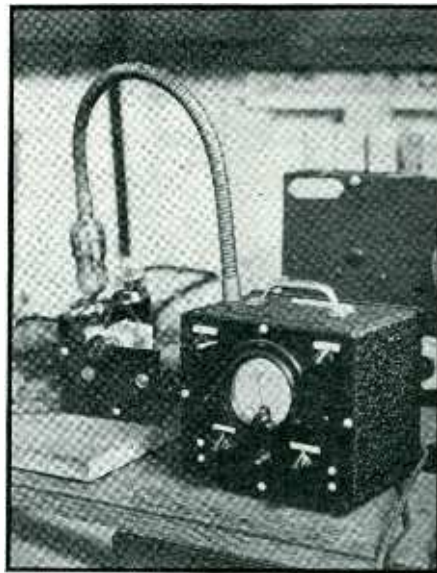

The complete unit in use

with its clip to connect to the tube. A lead of flexible braid with a similar clip is soldered to the shielding shell.

The normal line fluctuations caused some trouble originally but the network shown, with the assistance of the neon tube, obviates this difficulty entirely. By removing the resistance from the base of the neon tube, a very

VACUUM TESTING WITH A VENGEANCE

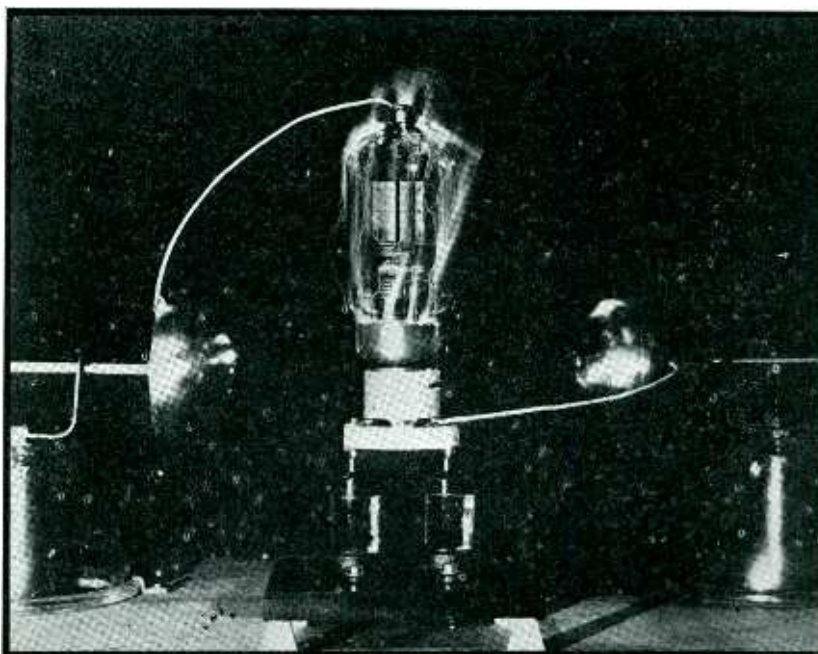

This Heintz and Kaufman Type 354 Gammatron is being subjected to an "over-all" high-voltage test at sixty cycles. Evidence of high vacuum in the envelope was disclosed by the fact that no glow discharge occurred inside the tube although heavy arcing did occur in the air outside



Read the "Inside Story" of this Radio Styling

TODAY, even the mass market for small radio receivers demands high quality in the styling and construction of cabinets. For success in this field, set manufacturers must supply it, often at moderate prices.

For cabinets of this type, as well as for the larger, more expensive table models, Bakelite Molded offers outstanding advantages. Its fine lustre and rich colors contribute much

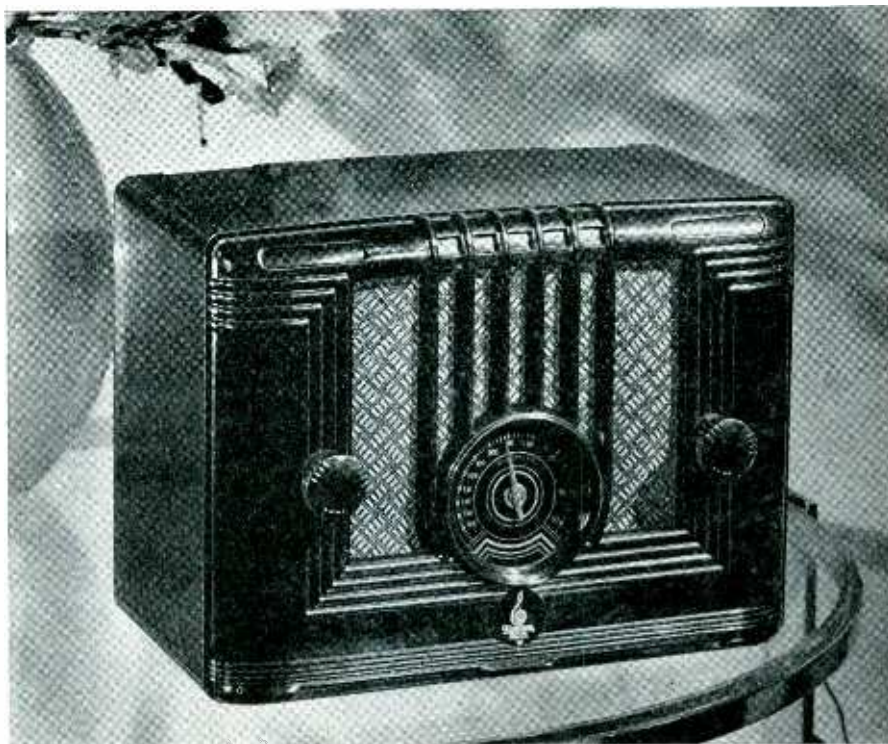

to the styling. Its ability to reproduce practically any form or pattern provides broader opportunity for originality in design.

In addition, the production shortcuts furnished by Bakelite Molded afford striking economies without sacrifice of quality. For example the new Emerson five-tube receiver cabinet pictured, is completely formed in two operations of the molding press.

Metal inserts are permanently positioned; grooves, cut-outs and

even the three external ridges, which replace the usual cushioned legs, are accurately formed in the mold. Polishing and finishing are unnecessary because the color is inherent in the material, and the lustre is imparted by the mold itself.

Radio manufacturers are invited to consult us regarding methods of obtaining maximum styling and production advantages through use of Bakelite Molded for proposed designs. Also, to write for our helpful booklet 13M, "Bakelite Molded."

BAKELITE CORPORATION, 247 PARK AVENUE, NEW YORK, N.Y.
BAKELITE CORPORATION OF CANADA, LIMITED, 163 Dufferin Street, Toronto, Ontario, Canada

BAKELITE

The registered trade marks shown above distinguish materials manufactured by Bakelite Corporation. Under the copied "B" is the numerical sign for infinity, or unlimited quantity. It symbolizes the infinite number of present and future uses of Bakelite Corporation's products.

THE MATERIAL OF A THOUSAND USES

ELECTRONICS — August 1936

33

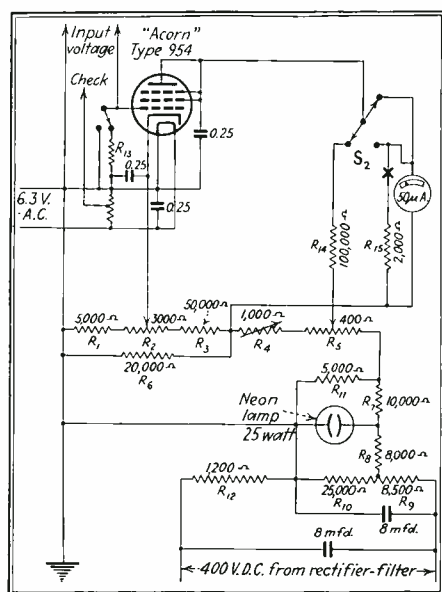

VT voltmeter connection diagram

good voltage control can be obtained and by using a heavy bleeder the additional 100 microamperes drawn by the voltmeter tube on full input, does not affect the regulation at all.

Referring to the circuit diagram resistor R_1 of 5,000 ohms is used to supply sufficient bias to the tube so that adjustment of R_2 , the 3,000 ohm bias control, will not cause damage, even at zero setting. With this limiting resistor the maximum current with a new tube is approximately 30 microamperes. This current should not fall to less than half this value during the useful life of the tube. Resistor R_2 is adjusted before each reading to a plate current of five microamperes, at which

value the net voltage between plate and cathode is 25 volts. Resistor R_3 of 50,000 ohms is used to supply bleeder current for the bias control. R_4 of 1,000 ohms, R_5 of 400 ohms and R_6 of 20,000 ohms combine to supply bucking current for zero adjustment. R_4 is set so that R_5 will adjust smoothly to zero meter reading near the center of its travel when the switch S_2 is thrown to zero position. This switch opens the bucking circuit in its other position to allow adjustment of plate current to the correct value. R_{14} of 100,000 ohms is the current limiting resistor for the bucking network.

Resistors R_7 , R_8 , R_9 , R_{10} , and R_{11} in conjunction with the neon lamp make up the voltage control network while R_{12} is the power supply filter. This entire network should be of 10 watt wire-round resistors to lessen the effect of heating after long continued operation. The filter condensers, rectifier tube and power transformer are of standard type, and supply 400 volts d-c, at about 50 ma.

The three 0.25 microfarad condensers should be of low impedance type with adequate grounding. Any fifty microampere meter may be used providing the shunt is made of equal resistance.

With this arrangement it will be found that one volt input gives a reading of approximately thirty-five and an input of two volts will give full scale deflection with the shunt on. Thus the most used ranges are well up on the scale and easily read.

The instrument should be calibrated against a very accurate standard with some means of supplying either 60 cycles or 1,000 cycles of the required voltage. The calibration should be square-law and can be drawn up on

two cycle log paper. It was found convenient to write the reading for one half volt, one volt, one and one half volts and two volts on a small card and attach it directly to the top of the metal case with a cover of clear celluloid to prevent soiling. Thus a point of calibration is always at hand for reference.

In conjunction with this feature a self checking tap was provided. A small 1,000 ohm potentiometer across the filament was adjusted at the time of calibration so that one volt is always available for checking when the line voltage is adjusted to 115 volts. This tap is connected to a terminal extending through the back of the cabinet.

A small screen door handle bolted to the top of the cabinet assists in carrying the unit easily. The power supply and all condensers and resistors are mounted on the steel sub-panel and bakelite panel. A terminal board provides easy connection to the leads from the tube when the sub-panel assembly is slipped into place in the cabinet.

The metal cabinet was finished in crackle and the gooseneck, handle and screws left in their original brass. Completed, the unit is very neat and workmanlike in appearance.

In development of r-f coils and i-f transformers, checking oscillators and the "Q" of coils it is very handy, always within reach and instantly movable. The long, flexible gooseneck and small size of the tube mounting head allow it to be inserted within a chassis, connected to the desired circuits, and not produce undesirable regenerative or degenerative effects.

The total cost of the unit including the type 600 Weston meter was approximately seventy-five dollars.

ULTRA-ULTRA-HIGH: A 30 KILOMEGACYCLE TRIODE

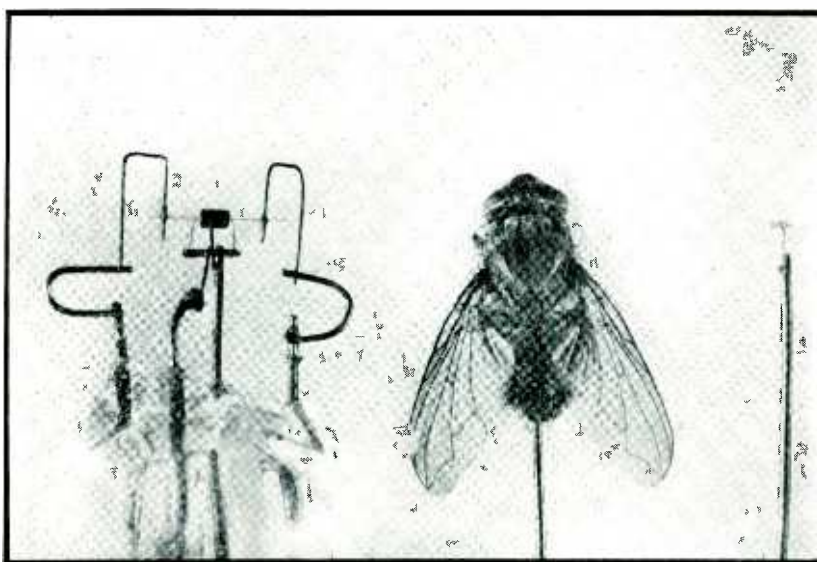

Claimed to be the world's smallest, these tube elements (left) generate waves about one centimeter long. Drs. G. W. Potapenko and C. Y. Meng of Caltech have already used the waves in studying molecular structure, find that they cannot penetrate fog. The fly gives an idea of the size; the grid (on point of pin at right) is 0.02 inch long

New York to Use Micro-wave Beam

THE COMMISSIONER OF PLANT and Structures, Frederick J. H. Kracke, of the City of New York has announced that before the end of the year New York City will possess a micro-ray beam radio link, the first in regular service in this country. The beam will connect the Municipal Building in City Hall Park with a transmitting plant of Station WNYC, which is now under construction at Greenpoint. The beam will be used as an emergency link only, but it will be a permanent feature of the station equipment and available for regular programs. In the event of wire failure between the Municipal Building and the station, the beam can be put into operation at once; neither rain, fog nor smoke will affect the transmission. The wave length of the micro-wave will be approximately 20 centimeters and the power output about 1.1 watt. The new Greenpoint transmitting station is expected to be ready for operation late this summer.

BULLETIN BOARD

S.S. WHITE FLEXIBLE SHAFTS

- August 1936 -

FACTS ABOUT FLEXIBLE CASINGS for Auto Radio Remote Controls

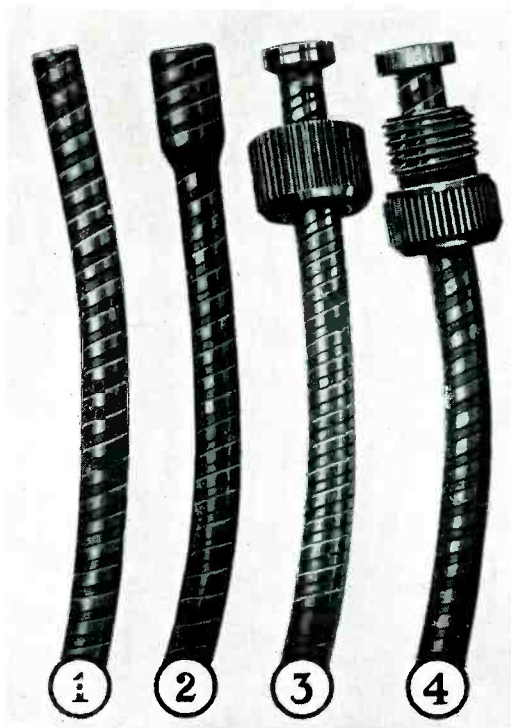

S. S. WHITE METALLIC CASINGS
for Auto Radio Remote Controls

1. Casing with plain end.
2. Casing with integral enlarged end.
3. Casing with integral flanged end and female nut.
4. Casing with integral flanged end and male nut.

CASINGS can be supplied with both ends the same or with any combination of ends. All casings are oil-tight and corrosion-resistant. They can be furnished with dull perkerized finish for exposed controls, or with galvanized finish for controls mounted on the dash.

The CASING is more than just a protective covering for the flexible shaft.

To assure entirely satisfactory shaft performance and proper installation and protection, the CASING should possess the following characteristics:

1. Necessary Flexibility combined with Sufficient Firmness to retain a given flexed position.
2. Minimum Radius of Curvature correctly proportioned to the minimum radius of curvature of the shaft.
3. Spring Tension sufficient to prevent the casing from kinking or bending too sharply.
4. Size of Bore properly proportioned to shaft diameter.
5. Resistance to Elongation to preserve predetermined length and facilitate assembly of unit.
6. Oil-Tightness and Corrosion Resistance.

S. S. WHITE CASINGS for auto radio application do possess all of these characteristics ... They were developed expressly for use with S. S. WHITE Radio Shafts ... They do assure the proper performance of these shafts.

So we stress the importance of always using the combination of S. S. WHITE Casings with S. S. WHITE Shafts for auto radio.

WATCH FOR THE SEPTEMBER BULLETIN

In it we will give you the engineering data on S. S. WHITE CASINGS for auto radio remote controls.

The S.S. WHITE Dental Mfg. Co. INDUSTRIAL DIVISION
10 EAST 40th ST. ROOM 2310 E. NEW YORK, N.Y.

MODERN JEAN VALJEAN



Reuben F. Brown, Assistant Sewer Maintenance Engineer of Los Angeles, takes a leaf from Victor Hugo as he begins an extensive inspection of the six-mile sewer system of the city. Let into the sewer canal from a manhole, Brown rides in a special boat several hundred feet a day, searching for acid erosion, earthquake cracks, measuring current flow and temperatures. He maintains contact with the surface crew by means of an earth induction communicating set. Special clothing and an oxygen mask protect him from lethal gases

New Antennas for KDKA and WJZ

TWO APPLICATIONS for approval by the FCC of tower construction have recently been made by Stations WJZ of Bound Brook, N. J., and KDKA at Saxonsburg, Pa. The WJZ tower, for which approval has been obtained will be a steel structure 640 ft. high, with constant cross-section throughout approximately 8 ft. in width. The tower will be supported by two sets of steel guy wires. In the earth directly beneath the tower will be placed a copper screen 150 ft. in diameter which will minimize sound losses which might occur at this point, and extending for more than 600 ft. in every direction will be more than 85,000 ft. of heavy copper rivets. Power will be fed to the tower through a 10-in. copper transmission line. Because of the hazards which such towers present to aircraft travel engineers of the Department of Commerce and of the National Broadcasting Company have been working together to perfect a system of night lighting, which is expected to be one of the most effective ever to be designed for this purpose.

The new tower for KDKA, the

world's pioneer broadcast station, will rise to a height of 710 ft. The tower will be triangular with cross sections and only 5½ feet on a side. The entire weight of the tower, 60 tons will be mounted on a porcelain insulator 18 in. in diameter. Unusual feature of the antenna is the fact that it will be insulated at the half way point in its height, permitting operation as a so-called half wave doublet. Antennas of this type have been used for some time in short-wave and ultra-high frequency transmission, but it is believed that it is the first application in the broadcasting field. A powerful aviation beacon will be mounted on the top of the tower for warning to itinerant flyers.

• • •

Photo Tube Timers on Indianapolis Speedway

DURING THE RECENT auto races held at the Indianapolis Motor Speedway checks were made with new photoelectric equipment for timing and photographing the finishes of the various races. The equipment takes a picture of each car for each lap, and marks the time at which the car went by on a strip of motion picture film. The problem of motor speedway timing is considerably different from that of horse race timing, since the cars intercept the beam of light which enters the photocell at a speed of 140 miles an hour which is in excess of 155 feet per second. Even at this speed the equipment will operate when only the head of the mechanic or driver intercepts the beam. At the recent races there were 33 cars starting and each made 200 laps, which makes a total of 660 pictures if all cars had finished the 500-mile race. The equipment was designed and installed by Ralph Powers of the Electronic Control Corporation in Detroit.

• • •

Photoelectric Mine Door Control

ONE OF THE MOST interesting installations of photoelectric relays and light sources used in the production of coal is installed in a Pennsylvania coal mine for automatically controlling the operation of mine doors. The installation consists of three photoelectric relays and three light sources as shown in the figure.

When either the "W" or "E" beams are interrupted by the train the door immediately opens. A timing relay causes the door to be reclosed after a definite time interval unless the beam "C" is interrupted. The interruption of the beam "C" cancels the timing cycle of the beams "W" and "E" to insure that the mine door will not close while the train is passing through or

standing in the doorway. As the end of the train passes either beam "W" or "E" which permits reestablishment of the beam, the door immediately closes.

The installation functions properly for any length of train. In the event the locomotive operator is instructed to move the train backward after passing

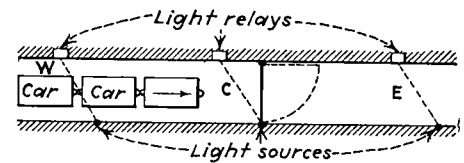

Interlocked mine-door control

either beam "W" or "E" which causes the door to open, the door will reclose after a predetermined time.

By automatically controlling the operation of the mine door, the train does not have to slow down and, therefore, increased haulage speeds are maintained and accelerating power saved.

WAVE ANALYSIS FOR THE MOVIES



Douglas Shearer of MGM and the "densitometer" he developed for analyzing the voices of the movie stars. Acting on the principle of a reflecting galvanometer, the machine makes a photographic record of the sound-pressure variations. Above is a pure-tone record made by Jeanette MacDonald; below, the baritone voice of Nelson Eddy

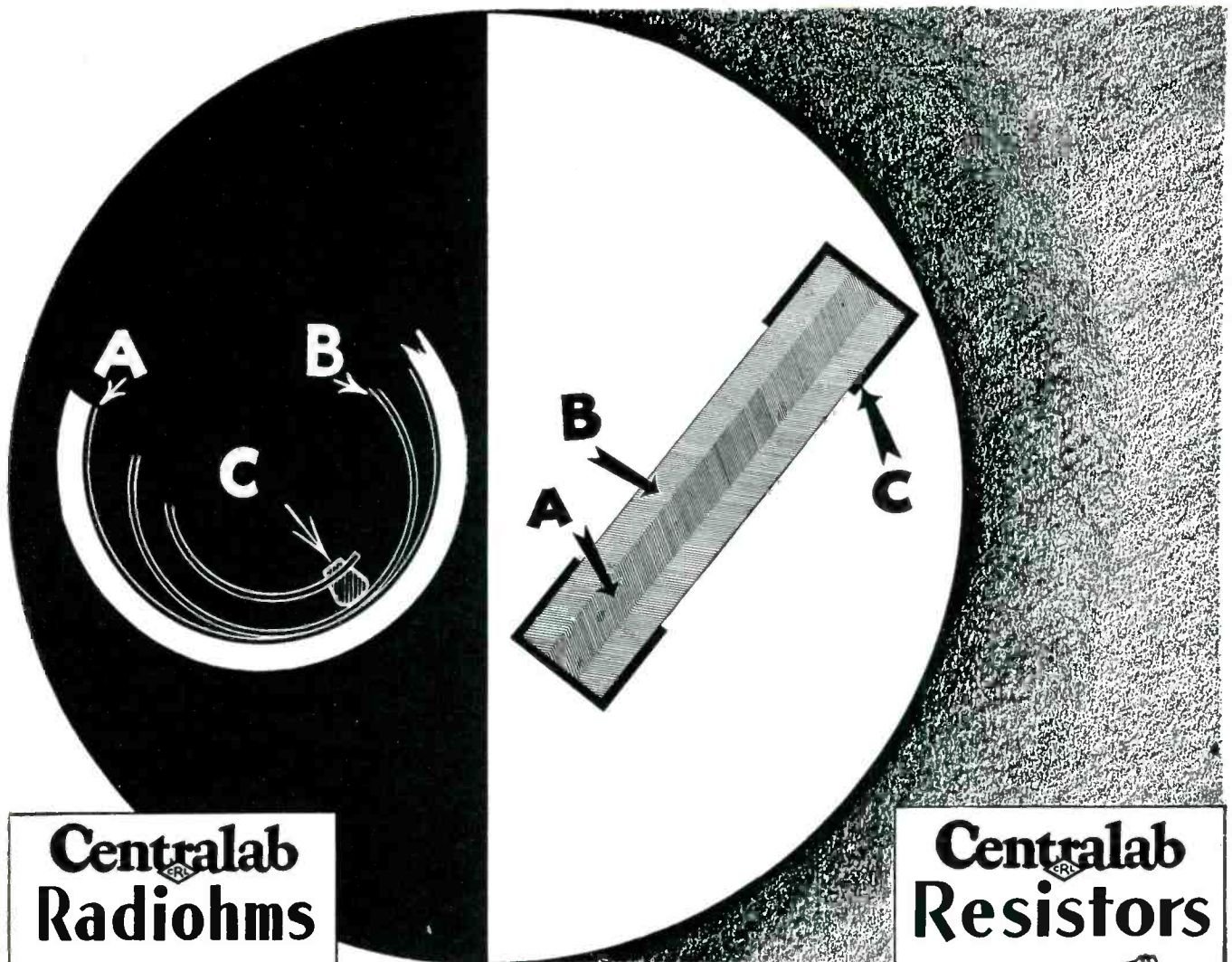

Centralab Radiohms



The A B C of Good Volume Control

A

Resistor strip on inner circumference of Bakelite case has longest possible length to insure smooth volume control and low noise level.

B

Highly polished non-rotating metal band contacts the resistor over a large area. Result, low contact resistance with light pressure, low-noise level, no resistance change or wear.

C

Oilless wood bearing provides the contact pressure and glides over the polished metal band when control is rotated. Permanently quiet and smooth turning.

Centralab Resistors

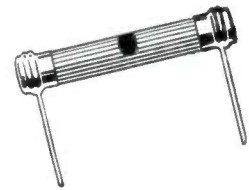

The A B C of Sturdy Resistors

A

Center core of resistance material is surrounded by a dense shock-proof ceramic, providing strength and protection against humidity.

B

Core and jacket are fired together at 2500 degrees F. into a single, solid unit, hard and durable as stone.

C

Pure copper covers the resistor end for wire lead contact. Contact to the resistance material is at the extreme ends only, providing uniform resistance and load distribution over entire length. End contacts do not short circuit part of resistance as in other types.

Know these "ABC's"

they are the basic and fundamental reasons for the overwhelming popularity of CENTRALAB parts for original equipment with the majority of the outstanding set manufacturers of this country.

CENTRALAB Div. of Globe Union Mfg.

Centralab

MILWAUKEE, WIS.

British Centralab, Ltd.
Canterbury Rd., Kilburn
London N. W. 6, England

Centralab
68-70 Rue Amelot
Paris, France

Modulation Measurement

[Continued from page 24]

operation. Button No. 1 permits rapid checking of the no-signal adjustment of the d-c meter. Button No. 2, of the lock-down type, shunts the d-c meter and disconnects the bucking battery when up, thus protecting the meter. Convenience of operation is further enhanced by connecting the d-c meter backwards, so that signal input increases its reading, and by connecting the input potentiometer and bucking battery rheostat so that clockwise rotation of the knobs also results in increased reading on the d-c meter scale.

The diode places a slight bias across the grid potentiometer even in the absence of signal input. Therefore if the signal input is low, it is necessary to recheck the no-signal reading of the d-c meter whenever the grid potentiometer setting is changed, because the portion of the no-signal diode bias included in the grid circuit changes with the potentiometer setting. If the r-f input circuit is tuned, as the writer prefers, the potentiometer can be set so as to obtain greater than the required d-c plate current increment, after which push-button No. 1 is pressed and the d-c meter reset to zero. The required d-c incremental reading is then obtained by releasing the push-button and

slightly detuning the input circuit. With high r-f input, the diode d-c voltage due to the signal is many times greater than the no-signal voltage, and the d-c incremental reading can be obtained by merely adjusting the potentiometer.

This circuit is applicable up to very high signal frequencies, and will be found especially useful when working with high-frequency, low-power generators. As shown by the curves, r-f input of less than 0.5 milliwatt at 5.5 volts will produce the necessary d-c plate current change of 1.4 ma. It is entirely feasible to use more sensitive meters, the limit in sensitivity being reached when the diode rectifier becomes seriously

non-linear. Beyond this point comparative readings can be obtained, but the per cent calibration is no longer valid.

The accuracy of the percentage indication at low and medium modulation frequencies is comparable to that obtained with more complex peak meters. For non-sinusoidal or asymmetrical modulation, the circuit will give a more logical per cent reading than a peak meter. For high modulation frequencies, the per cent indication must be corrected for frequency discrimination by the rectifier meter. A further refinement for covering a wide range of modulation frequencies is the substitution of resistance in each branch of the plate circuit for the choke and ballast resistance indicated in the diagram, and recalibration of the d-c meter increment according to Eq. (3).

Field Strength Measurement

[Continued from page 22]

gated by field strength tests. Within this region predictions of fair accuracy can be made from a thorough consideration of the test data; ground conductivity and topography can change so rapidly, however, that subsequent results may vary by a seriously wide margin from the test predictions beyond the exact area which was investigated.

Another difficulty, obscure but very practical, arises in some cases due to the geology of the territory. If an investigation of a given area is made on an existing or a portable station and the ground conductivity determined on this basis, predictions for a station similarly located but operating on another frequency may be seriously in error, due to the different penetrations into the ground of the two frequencies involved. This gives rise to different values of ground conductivity and in such cases a study of the geology is warranted before the choice of a test frequency is made.

The usefulness of any field strength measurement system is greatly extended by the addition of equipment permitting the continuous recording of the measurements. This feature may be applied to most types of existing measurement equipment (with more or less difficulty, depending upon the system of measure-

ment) and the increased flexibility warrants the cost of the additional apparatus involved.

It may be said that apparatus suitable for measurements of this type is one of the most useful tools available to radio transmission. The economic value of the data which can be obtained more than justifies the cost of the equipment.

The Canadian Radio Commission recognizes the value and importance of such measurements and has been consistently active in utilizing them, and in developing equipment of wider application for use in measurement and recording. A mobile measuring unit has been in operation for two years and has made field strength measurements in all parts of the Dominion.

In addition, semi-permanent installations of measuring and recording equipment have been made for special investigations of interference. Results of such measurements have provided facts which have very measurably aided in alleviating the interference; they have been of decided value in raising the performance standards and efficiencies of Canadian broadcasting stations.

REFERENCES

- ¹ Direct Ray Broadcast Transmission, T. L. Eckersley, *Proc. I.R.E.*, October, 1932.
- ² On the Propagation of Electromagnetic Waves, B. van der Pol, *H.F.T.*, April, 1931.

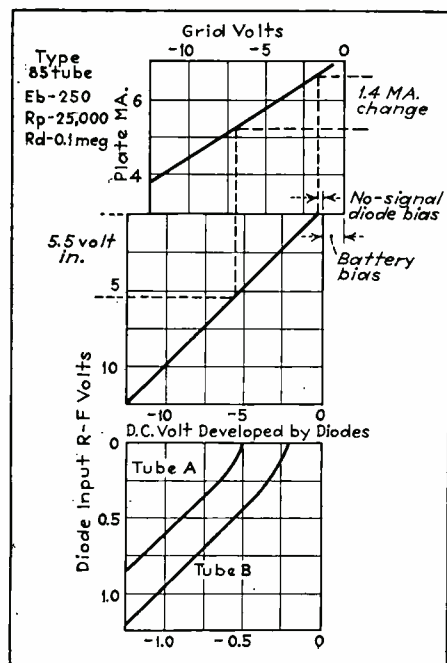
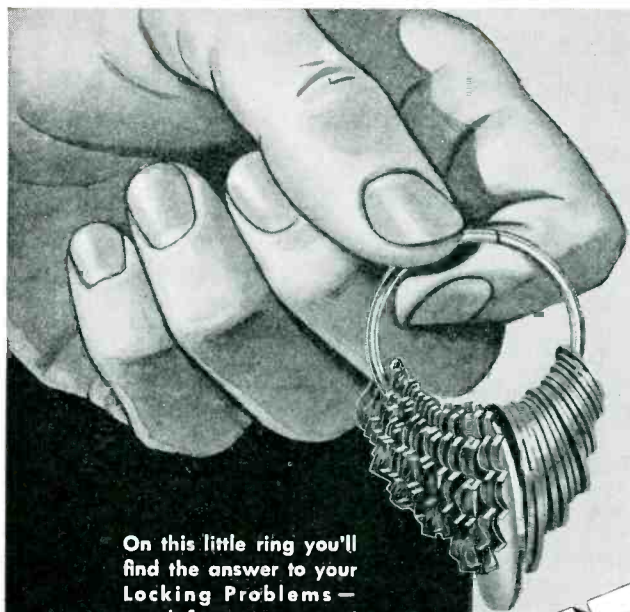

Fig. 5.—Characteristics of meter



On this little ring you'll find the answer to your Locking Problems—send for yours now!

FREE

Accept this
TEST RING!
and discover

THE SENSATIONAL LOCKING POWER OF SHAKEPROOF'S NEW *tapered-twisted* TOOTH

LEARN for yourself by actual trial on your own product, or by the most severe tests you can devise, how Shakeproof's Triple-Action Locking Principle defies vibration. Look closely at the exclusive tapered-twisted teeth and you'll quickly appreciate why a Shakeproof Lock Washer holds any nut or screw absolutely tight. Note how each tooth is tapered, the width decreasing as the degree of twist increases, producing a substantial line bite at initial contact—the top edge biting into the nut or screw head, the lower edge digging into the work. This construction places a sturdy strut between nut and work, positively preventing backward movement of the nut, and also provides a strong spring-tension which keeps the locking force continuously active. This triple-action lock cannot be loosened by vibration. In fact, the greater the vibration the deeper the tapered-twisted teeth bite in—making the lock tighter than ever.

PROTECTS PERFORMANCE—CUTS COSTS!

If you use bolts or screws in your assemblies, you need the definite, positive protection against the loosening effects of vibration that Shakeproof Lock Washers provide. Don't be satisfied with ordinary lock washers—be sure you have the best. Test Shakeproof Lock Washers against any other type and the results will tell you why thousands of America's leading manufacturers have adopted Shakeproof. Mail the coupon today for your free Test Ring!

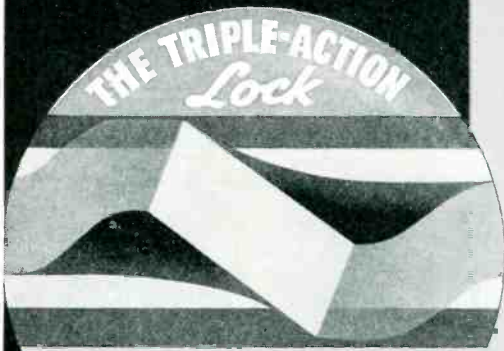

STRUT-ACTION+SPRING-TENSION+LINE BITE



U. S. Patents Nos. 1,852,486—1,909,476—1,419,564—1,604,122—1,909,477—1,782,387—1,943,600. Other Patents. Patents Pending. Foreign Patents.

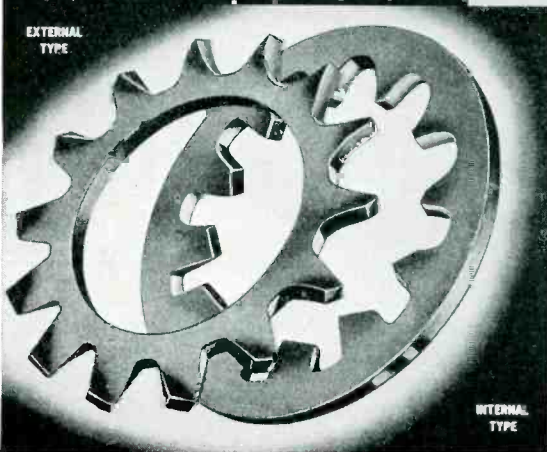

Distributor of Shakeproof Products
Manufactured by Illinois Tool Works
2501 N. Keeler Avenue Chicago, Illinois

Mail this Coupon TODAY

SHAKEPROOF LOCK WASHER CO.
2539 N. Keeler Avenue, Chicago.

Gentlemen:
Send the FREE Test Ring of Shakeproof Lock Washers by return mail so that we may judge their locking power on our own products.

Name _____
Firm _____
Address _____
City _____ State _____

THE ELECTRON ART

RADIO in France as revealed by the International Exposition in Paris. High frequencies, their measurement and generation continue to occupy a major place in contemporary literature.

Notes on the Paris International Radio Exposition

By WINSTON E. KOCK

THE THIRTEENTH ANNUAL International Radio Exposition was held in the Hall Citroen in Paris from May 20 to June 2, 1936. There were 163 exhibitors represented and the display covered an area of one square mile. Exhibiting U. S. set manufacturers included Zenith, American Bosch, Scott All-Wave, Universal (Kadette), Motorola, and Lyric Radio; parts manufacturers were more fully represented.

Television and metal tubes were the features of the exhibition. Television broadcasts of 180-line pictures were made regularly each day from 4 to 5 o'clock from Paris, and at the exposition one large hall was used solely for showing examples of television reception. Throughout the main exposition several individual exhibitors also displayed television receivers in operation. Nevertheless, there is as yet no quantity production of television receivers in France; one German Exhibitor, Radio A.G.-D.S. Loewe, has been prepared for several months for mass production of sets but complications in Germany have prevented such a step. Good images in black and white are obtainable with the Loewe set. The television broadcasts consisted solely of vocal solos, recitations, and announcements; so that good lighting was easily available for the subject.

Metal tubes were used in many of the receiving sets displayed and the majority of these tubes were of American manufacture. However, several French firms are manufacturing the all-metal tubes and also the type having a glass envelope and metal shell. A great many French sets utilize American parts in various places in the set, such as speakers, tubes, condensers, etc.

Prices are still very high in France. A typical table model set lists at 2,750 Francs, the equivalent of \$180, and an auto radio set lists at 1,500 Francs or \$100. Console models range from 5,000 to 12,000 francs (\$330 to \$800).

Several novel designs were displayed, including a radio modelled after a famous French castle, one built in the form of a baby-grand piano (3 feet high and 2½ feet long), and a set with push button tuning. In this set, two rows of push buttons connected to fixed condensers permitted any one of

120 stations to be received by simply pressing two buttons.

The most noticeable defect in all the sets displayed was the lack of fidelity. The bass was completely absent and highs above 4,000 cycles were extremely weak. Since about 90 per cent of the sets sold in France are table models, the baffle area would prevent high fidelity reproduction *even if it were present in the received signal*. However, this is not the case; the studio cables and studio equipment are such that high quality reproduction as we know it is not obtainable even with high fidelity receivers. The frequency separation of broadcasting stations is less in Europe than in America, being usually 9,000 cycles and sometimes 8,000 cycles which accounts for the receiver cut-off at about 4,000 cycles. The poor fidelity of the receivers shown was so noticeable that unquestionably a sensation could have been created by the display of one high fidelity U. S. set playing high quality recordings of symphonic works.

Volume Expansion

CROSLY'S method of volume expansion by which the low passages are depressed somewhat below their normal volume so that a wider range of volume is experienced has been described in *Electronics* (March 1936, P. 9). The method practically applied with its mathematics worked out for several test cases will be found in *The Wireless World*, May 22, 1936 in an article by R. H. Tanner and V. T. Dickens.

• • •

A Wave Meter for Decimeter Waves

[LOTHAR ROHDE, LABORATORY FOR INDUSTRIAL PHYSICS, MUNICH] When working with wave-lengths between 30 cm. and 60 cm. it becomes necessary to ascertain the presence of oscillations in the desired range or to make sure that the wave-length remains constant. Lecher wires are not very convenient for this purpose, and it is simpler to use tuned circuits which have been calibrated with the aid of Lecher wires. Four tuned circuits consisting of a loop of wire and a two-plate condenser adjusted by means of a micrometer screw which may be read to 0.001 mm. cover

FACSIMILE TELEPHONE IN GERMANY

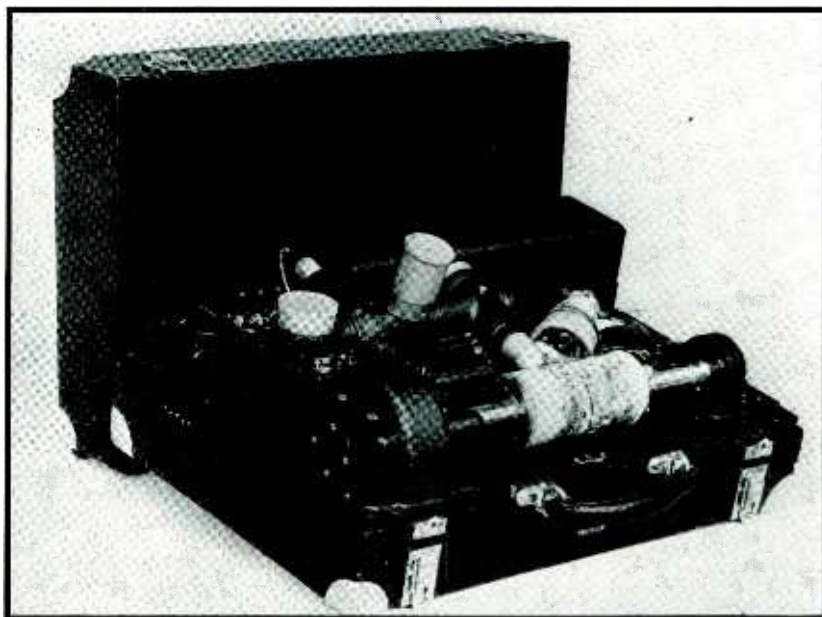

This highly portable scanning outfit is used as the transmitter for sending photographs by wire in Germany, where it was developed by Siemens and Halske. The photocell (in the T-shaped member) views a tiny spot of light directed on the photograph by the 4-volt exciter lamp, while the drum revolves 60 times per second. Photos 5⅛" by 7⅛" can be handled; the carrier frequency used is 1300 cps



Join This Network *

○ F GOOD stations who are using the General Radio Type 731-A Modulation Monitor. There are four main reasons why these stations are G-R equipped:

1. The General Radio Modulation Monitor is reasonably priced. Complete with tubes and accessories, ready to operate, it costs \$195.00.
2. It not only guarantees that your station will comply with the FCC regulations, but it assures you of a better signal in all modern high-fidelity receivers, with increased coverage.
3. It is a separately operated part of the General Radio Class 730-A Transmission Monitoring Assembly which is in use by many of the finest stations to insure absolutely peak transmitter performance at all times.
4. It is a product correctly designed, carefully manufactured, accurately calibrated and rigidly inspected by General Radio with its advanced manufacturing organization. Years of useful service, as is the case with all G-R products, are assured.

We are having a difficult time keeping up with orders, but if yours is received soon we should be able to make delivery from the next production lot sometime early in September.

** Only a partial list of purchasers of the G-R Monitor
For additional details write for Bulletin 41-E.*

**GENERAL RADIO COMPANY
CAMBRIDGE, MASSACHUSETTS**

LONDON'S TELEVISION TOWER



This steel structure, installed on the Alexandra Palace in North London, will radiate sight and sound signals in the forthcoming BBC tests

• • •

Radio Abroad

THE FOLLOWING notes are made up from bulletins of the Bureau of Foreign and Domestic Commerce, of the Department of Commerce.

Uruguay—Better market for imported receivers, especially American, because of better economic condition and lack of enthusiasm for locally made sets. Market for auto radios is dull because many cars are imported with radios already installed and owners of old cars are not taking to radio very fast.

Venezuela—New stations, YV14RC, 6,270 kc. and 882 kc. and YV15RC, 5,910 and 1,400 kc.

Czechoslovakia—863,326 licensed receiving sets as of March 31, 1936. Licenses now must indicate number of tubes, brand and chassis number.

Germany—Registered listeners on April 1, 1936 was 7,583,841 or 110,520 more than a month previous. First 5 months of 1936 saw a turn over of 520,000 sets compared to 699,030 the year before.

United Kingdom — 776,663 new licenses during February making a total of 7,573,793.

Sweden—883,845 licensed sets are in use in Sweden, a saturation of 141.8 per 1,000. The first three months of this year saw the greatest increase for any quarter.

South Africa—134,233 licenses are in effect. The first locally made receiver is on the market; known as the Viking it sold to the extent of 150 during the week of their Rand Agricultural Show.

New York Y.M.C.A. Offers Electronics Courses

THE TECHNICAL SCHOOL of the New York Y.M.C.A. at 5 West 63rd Street, New York, announces the formation of courses in Electronics, available in both day and evening classes, which will begin Monday, September 21st, 1936. The courses are intended to give a thorough grounding in all phases of electronic science, and are given in two terms, the first of a more elementary character for students not familiar with the fundamentals of electricity, and the second for more advanced students and engineers who already have a working knowledge of the fundamentals. Each term of the day course is given in approximately four months; the evening course requires approximately eight months per term. Both the elementary and advanced courses are given simultaneously, and it is possible for properly qualified students to take the elementary work during the day, and the advanced work in the evening.

The elementary course includes instruction in a-c and d-c circuit theory, algebra, and the simpler vacuum tube circuits, particularly as applied to radio. The advanced course is open to students who have completed the elementary work, and to others who have substantially equivalent training; it is intended for men who are familiar with the basic principles of electricity and its engineering applications but who

• • •

TUBE-CONTROLLED LATHE



This automatic metal-working lathe shapes its work from a black-and-white pattern which is scanned by a photocell. It was designed by a Russian, V. S. Vikhman

MEASURES 10^{-26} GRAM



The latest mass spectograph at the University of Chicago will detect differences in weight of the order of 10^{-26} gram. Atoms from a hot spark are drawn through a slit, acted on by magnetic and electric fields, finally hit a photographic plate, forming a spectrum which reveals the relative weight of the atoms

• • •

desire specialized training in the newer and more advanced applications of electron tubes. This latter course, which may prove of interest to readers of *Electronics*, contains the following divisions: Basic Electron Theory, including charge and mass relationships, modes of electron emission, vacuum tube structures; Electron Tube Circuits; Practical applications, including lecture demonstrations and trips to outside installations; Electronic Systems; and Industrial Electronics, including control and measurement functions of thermionic and photoelectric tubes in industrial use. Approximately one third of the course is devoted to laboratory work.

The teaching staff of the Electronics Courses includes Mr. J. L. Hornung, formerly radio instructor at New York University and coauthor of "Radio Operating Questions and Answers" and "Practical Radio Communications"; Mr. Ralph Batcher, consulting engineer and member of the Board of Editors of the I.R.E. Proceedings; Mr. Paul A. Von Kunits, Chief Engineer of the Bruno Laboratories; Mr. Chester Smith, instructor in motion picture projection and operating. The evening division advanced course will be given by Donald G. Fink, Associate Editor of *Electronics*. Further information may be obtained directly from the office of the school at 5 West 63rd St., New York City.

Aircraft Compass

[Continued from page 15]

screen since an independent AF unit is connected across the constant intensity non-directional antenna amplifier system and does not effect the directional circuit. Strong static or nonperiodic atmospheric disturbances produce corresponding erratic spotted images of short duration. However, the continuous, normal superimposed directional indication is clearly visible in conjunction with the static disturbances. Accurate flight through storms has been accomplished in spite of poor signal conditions. The directional indicator may be used to determine the direction of a distant storm in order that the pilot may fly around it.

An interfering station would normally superimpose its signal upon a null indicator to destroy its accurate null indication. However, an interfering signal with Hefe's right-left indicator merely produces a minor pattern of its own and the major pattern due to the preferred station is clearly distinguishable. Errors due to interfering stations are thus virtually impossible.

Night effect, the bug-a-boo of night flying with radio guidance, is overcome with the cathode-ray direction finder. In this case, the erroneous polarization of the wave front, although presenting an out-of-phase component, has for its major component the normal flight direction which produces the proper directional and sense indication upon the cathode ray tube.

Night flying tests have shown that the directional accuracy of the instrument is not only unaffected by the night effect but night effect is evidenced upon the indication as a non-correctible ellipse, the width of which continually changes according to the polarization effects. Flight during the night using the narrow "ellipse" instead of the straight line is very practical since the inclination of the ellipse is the determining factor of the right left indication and its deflection from the vertical is readily ascertained and the pilot can keep the indicator "on-course" to his destination.

Another useful contribution of Hefe for aircraft radio guidance is an ingenious stream line loop antenna. A loop wound on a coil of relatively small diameter such as 8" is rotatably mounted within a stream lined housing which is in turn rigidly attached to the aircraft. The U. S. Coast Guard has adopted this type of stream line loop as standard equipment. This loop may be seen mounted upon one of the Coast Guard planes of the photographs. The effective reception by the 8" diameter loop is equivalent to the common tubular metallic shielded loop of 18" diameter.

The aerodynamic resistance of the stream lined loop is negligible, particularly as compared to the toroidal metallic loop. It is to be noted that the low aerodynamic resistance of the loop inclosed in the stream lined housing is independent of the angular position of the loop coil within. The stream line housing is mounted with its minimum resistance in the line of flight.

The total weight of the cathode ray right-left indicator has been designed under seventy pounds and is comparable with the weight of other types of radio compasses. The sensitivity of the receiver is such that a field strength of two microvolts per meter may cause a full deflection of the indicator. Automatic volume control provides predetermined sensitivity of deflection during extended flight periods. The power supply may be directly operated from the plane 12 volt storage battery with a power drain of about 100 watts. The deflection sensitivity of the indicator may be adjusted so that a 2° departure from on-course would deflect the indication 15 or 20 degrees from vertical.

Other designs embodying Hefe's basic principle have been made with dynamometer and electrostatic indicating meters in place of the cathode ray tube. However the cathode ray tube is particularly useful during adverse weather conditions where the signal is visually distinguishable from the static. The cathode ray tube has proven itself to be a reliable, rugged instrument on board an aircraft. The life period of a cathode ray tube is at least that of the vacuum tubes employed in the radio circuit and therefore regular servicing and replacement precautions only need be effected.

TRUTHS

A man can work with maximum skill and speed only a certain number of hours per day. It is a mistake to work him too long and too hard—any small gain in productivity is sure to be offset by losses in quality.

Help your men maintain their physical well-being. Reward them sufficiently to make jobs worth while—and you have made *loyalty* their first thought—that is worth more than the outworn word "efficiency."



SUPERIOR TUBE COMPANY

NORRISTOWN, PA.

25 miles from Philadelphia

100 Miles from New York

We Manufacture
Fine Tubing
in Small Sizes

Electron Oscillators

(Continued from page 11)

Morrell on the other got such divergent results when they used similar circuits is undoubtedly that in the B-K case the filament emission was much more copious than in the G-M case. With the higher emission, $r_p r_g$ would be lower.

If equation (6) expresses the frequency of the B-K oscillator, it should be possible, without making any absurd assumptions, to throw this equation into the form $\lambda_o^2 E_g = k$, where λ_o is the wavelength corresponding to ω_o . The transformation is readily effected by assuming that both r_p and r_g are proportional to the first derivative of the grid voltage with respect to the grid current and that the grid current varies as the 3/2 power of the grid potential.

Application of Phase Equation

Suppose X is the reactance of an inductance coil instead of the reactance of a transmission line. Then $X = L_1 \omega$, where L_1 is the inductance between the grid and the plate. Equation (5) can then be written,

$$\omega^2 = \frac{1 + L_1 K \omega_o^2}{L_1 (C_m + K)} \dots \dots \dots (7)$$

This equation shows how ω_o affects the frequency in an Ultraudion oscillator or any simple Colpitts, and also how the tube capacities affect it.

Now let us suppose that X is the reactance of a shorted transmission line having a characteristic resistance $Z_o = (L/C)^{1/2}$, length l , inductance L per unit length and capacity C per unit length. Then, writing λ for ω , $X = Z_o \tan(2\pi l/\lambda)$, and equation (5) may be written,

$$\tan \frac{2\pi l}{\lambda} = \frac{\lambda C}{2\pi [C_m + K - K \frac{\lambda_o^2}{\lambda^2}]} \dots \dots \dots (8)$$

With the aid of (8), the length of line required to generate any given wavelength can be computed if the other factors are known. By computing l for a large number of values of λ , a graph can be constructed.

The following values were used in computing the curves herein:

$C_p = C_m = 3.2$, $C_g = 2.2$, $K = 1.3035$, and $C = 0.0684$, all in micromicrofarads; $L = 16.25$ cm and λ_o , when finite, 100 cm.

The curves in Fig. 3 have been computed from

$$\tan \frac{2\pi l}{\lambda} = \frac{\lambda C}{2\pi (C_m + K)} \dots \dots \dots (9)$$

obtained from (8) on the assumption that λ_o is infinite. One of the curves is for $C_m = 3.2$ and the other for $C_m = 0$. The interesting feature about these curves is that λ increases uninterruptedly as l increases. Therefore equation (9) represents pure G-M oscillations.

The next set of curves, shown in Fig. 4, has been computed on the assumption that $\lambda_o = 100$ cm. Equation (8) gives directly the values of l in the first mode only. The values for the second and third modes have been obtained by adding $\lambda/2$ and λ to each of the computed values. This is now allowable since the circuit cannot oscillate at a wavelength greater than 100 centimeters.

Although the inverse tangent is multiple-valued, there is only one value of λ for each value of l . The circuit continues to oscillate in a lower mode until the condition $\lambda = \lambda_o$ forces it to drop to a lower wave in the next higher mode. The circuit "prefers" to oscillate at the longer wave, as was pointed out by Gill and Morrell, and the reason for this preference is obvious. When the circuit is oscillating near the limiting wave, the inductance in the circuit is greatest for a given capacity. Any oscillator will oscillate more easily and intensely when the inductance/capacity ratio is high than when it is low.

Although the curves in Fig. 4 show the characteristics of the experimental curves of Hollmann, there is a sharp contrast between the two in the manner they approach the limiting wave. In the computed curves the angle of incidence is large; in the experimental curves it is small, almost zero. Several reasons may be adduced to explain the difference,

and some of the more likely will be discussed.

In order for the curves to approach $\lambda = \lambda_o$ slowly and thus make the oscillator one of the B-K type over considerable portions of the Lecher wires, the right hand member should be as large as possible when $\lambda = \lambda_o$ and it should become as small as possible for the slightest deviation from this equality. The only way to make the tangent infinite when $\lambda = \lambda_o$ is to make C_m zero. The curves in Fig. 5 have been computed on this basis. It will be observed that these curves are more nearly like the experimental curves than are the curves in Fig. 4. But still the angle of incidence of the curves at $\lambda = \lambda_o$ is so large that there is no suggestion of the B-K condition. The change in wavelength at the jumps from one mode to the next is also too great.

It will also be noticed from (8) that if C_m is zero and C/K is small, the curves will approach the $\lambda = \lambda_o$ more slowly in the region of oscillation. One set of curves was computed in which the type was nearly pure B-K, but it was not retained because the required value of C/K was absurdly small.

Is there any justification for assuming that C_m is zero? There is. The assumption was first made that C_m was lumped at the end of the line. In practice this is not so, for C_m is distributed over the leads to the grid and the plate and over the extent of these structures themselves. There is also distributed inductance in this region. Therefore C_m and the internal inductance constitute a non uniform extension of the external line. Hence there is more reason for assuming the C_m is zero than assuming it has the value obtained by static measurement.

Another factor that should not be overlooked is that the first observed mode may actually be the second. The first may be so close to the tube that it cannot be observed conveniently. It may even be entirely inside the tube. As will be observed, the slope of the computed curves becomes less the higher the mode.

Again, if the two meshes accounting for λ_o be regarded as a tuned circuit, there would be a tendency for this circuit to take control over the oscillation from the line. This effect would be greater the higher the resistance in the line. The com-

puted curves are for zero line resistance. That resistance in the line affects the course of the curves is corroborated by experiment.

Still another possibility is that the reactance of the bridge affects the curves. If the bridge reactance is appreciable, the reactance of the open end of the line beyond the bridge also must be taken into account. A set of curves was computed for a line of total length 100 cm, a bridge with inductance of 32 cm, and $C_m=0$. The effect of the terminating impedance from about 80 to 100 centimeters was to decrease the slope of the curves slightly. At 80 cm, $\tan(2\pi l_o/\lambda)$ became infinite for the first time and for lower values the effect of the terminating reactance was most erratic. For certain values of λ the required value of $\tan(2\pi l/\lambda)$ was complex. Here l_o stands for the total length of the line and l for the length from the bridge to the tube.

The B-K oscillator has always been associated with ultra-high frequencies, and it has gained the reputation that it is especially suited for such frequencies. This reputation it does not deserve. The best that can be said for it is that it is incapable of oscillating below a certain critical frequency, which may be made high by making the product $C_p C_g r_p r_g$ small. The Ultraudion with a pair of Lecher wires connected to the grid and the plate is just as suitable for the generation of ultra-high frequencies, provided that the line be made short enough, or if long, provided an external constraint be placed on the line to force it to oscillate in one of the higher modes. The feedback oscillator would be more efficient than the electron oscillator.

Since λ_o is practically infinite in the feedback oscillator, the curves in Fig. 3 may be taken as the relation between the wavelength and the line length in the first mode of oscillation. To get the higher modes it is only necessary to add multiples of half wavelengths to the abscissas.

It might be pointed out that C_p and C_g are essential to oscillation in any Colpitts circuit. They need not be as large as they usually are. In fact, the smaller they are the more intense will the oscillation be for a given wavelength, and the shorter the wavelength that may be generated with a given intensity. C_m , on the other hand, is not essential to oscillation and is always a nuisance.

Assure better performance
with **S.S. WHITE**
MOLDED
RESISTORS

1,000
OHMS
TO
1,000,000
MEGOHMS

Featured by noiseless operation, permanent resistance value, rugged mechanical strength and non-hygroscopic material, S. S. WHITE Resistors meet and satisfy every resistor need of the commercial, and the laboratory and experimental fields. Recommended particularly for air craft radio and for all applications where noiseless performance is vital. WRITE for descriptive circular showing types and capacities.

NOISE TESTED

At slight additional cost, resistors will be supplied individually "noise-tested" to this specification: "For the complete audio frequency range, resistors shall have less noise than corresponds to 1 part in 1,000,000."

The S. S. WHITE Dental Mfg. Co. INDUSTRIAL DIVISION

10 East 40th Street, Room 2310E, New York, N. Y.

Newly
Designed

REMLER

AR-69 Preamplifier
for VELOCITY or DYNAMIC Microphones

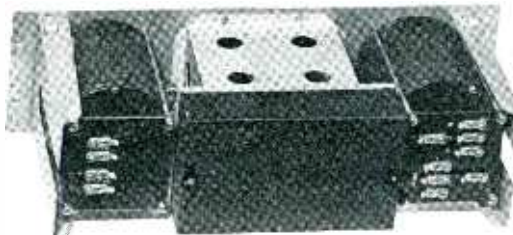
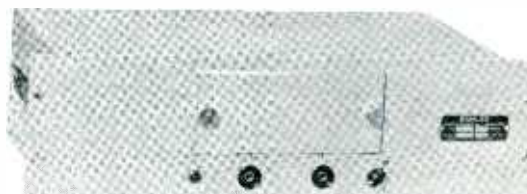

May be had in Dural or Black finish Panel. Dimensions: 19" x 5 1/4". Depth, including Dust Cover, 11 3/4". Very moderately priced. Write for details.

Circuit: Two stage, resistance coupled. Highest quality, self-shielded transformers. Input transformer cushioned in rubber. Output transformer parallel fed. 2 Type 77 tubes, triode connected. Gain 42 db. Response: plus 1/4 to minus 1 3/4 db. from 1000 cycle reference over the range 40 to 12,000 cycles. Also available at 36 db. gain with rising high frequency response (plus 4 db. at 10,000 cycles) to compensate for other apparatus.

Input: 30 Ohms standard, 250 Ohms on special order. Input is balanced to center tap. Output: 200 Ohms. (May be paralleled for 50 Ohms.)

Power Required: 180 to 250 volts plate (less than 2 mils drain) and 6 volts A. C. or D. C. (at .6 amperes drain). Plate current jacks on front panel. Tubes accessible from front.

REMLER COMPANY, Ltd. 2101 Bryant St., San Francisco

REMLER—THE RADIO FIRM AS OLD AS RADIO

MANUFACTURING REVIEW

New Products

Portable Engine Generator

A GASOLINE ENGINE generator listing at \$198.50 is manufactured by the Gruenhagen-Callwell, Inc., 216 Santa Domingo Ave., Lomita Park, Calif. The unit which contains a single cylinder 4-cycle engine operating at 3600 r.p.m. and a 150-watt continuous duty generator, weighs less than



20 lb. The unit runs 12 hrs. on a gallon of gasoline, the gasoline tank holding 1 quart. By using new two type magnetic alloys for the steel structure, no exciting unit is necessary in the generator. Generator output is at 360 cycles, used rather than the conventional 60 cycles because of the much smaller generator thus made possible. It may be used for lighting or with any other type of load capable of using 360 cycle alternating current at 125 volts.

"Ultra High Range" Resistor

THE INTERNATIONAL Resistance Co., 401 N. Broad St., Philadelphia, announces a line of stable, high range, non-inductive, high voltage resistors, types "FH-1" and "MG." The type FH-1 resembles a metallized filament resistor, but is made with special stabilizing processes. Available in values up to 10,000 megohms for low voltage application. Type MG is available from 20 megohms to 100,000 megohms and in voltages up to 4,000 volts. Both types are described in a catalog available on request.

Automobile Aerial

AN AUTO AERIAL known as model 4 R.C. Streamline is announced by the Ward Products Corp., 2135 Superior Ave., Cleveland, Ohio. This aerial is of the running board type, completely rubber covered and containing a

molded lead wire connection. A double loop conductor is used as the pick-up element. The unit weighs 6 lb., individually packed, and lists at \$2.95.

Harmonic Filter

THE RADIO ENGINEERING & MANUFACTURING Co., 26 Journal Square, Jersey City, N. J., announce a new harmonic filter for operation on the output circuits of broadcast and communication type transmitters. Known as type LP-10A Harmonic Filter each unit is individually engineered to the specified undesired harmonic. The type illustrated may be supplied for suppressing one frequency in the bands 1100 to 3000 kilocycles and 1650 to 4500 kilocycles when the fundamental operating power does not exceed 1 kilowatt. A bulletin describing the filter is available upon request.

Voltage Regulator

WARD LEONARD ELECTRIC COMPANY, Mt. Vernon, New York, has developed an electronic voltage regulator which performs the same functions as do the other and older types, but the method by which regulation is effected is entirely independent. Type EF regulators are control rectifiers deriving their power from the a-c generator and de-

Transformers

CORO-COIL COMPANY, 229 Chapman St., Providence, Rhode Island, offers a line of r-f transformers of the iron core type. These transformers are made in two groups, the 50 series and the 60 series. The 50 Series is available for communication receivers requiring the ultimate in selectivity, while the 60 series is best suited for broadcast application demanding high gain and full band-width response. Both types use the newly developed magnetic alloy material known as Magicore which exhibits no eddy current or hysteresis losses when used in a radio frequency field. All coils are wound with Litz wire with the exception of the 175 kc. types. Padding condensers are zero drift mica type on Isolanite bases. The capacity range is sufficient to permit readjustment of 465 kc. units to other popular I. F. frequencies from 550 to 456 kc.

livering the rectified d-c current to the shunt field of the exciter in an amount which is a function of the a-c generator potential. The diagram shows the elementary circuit involved which has the following advantages: 1. No moving parts. 2. No maintenance. 3. No replacement except tubes. 4. Simple to install. 5. Low initial cost. 6. Quick acting.

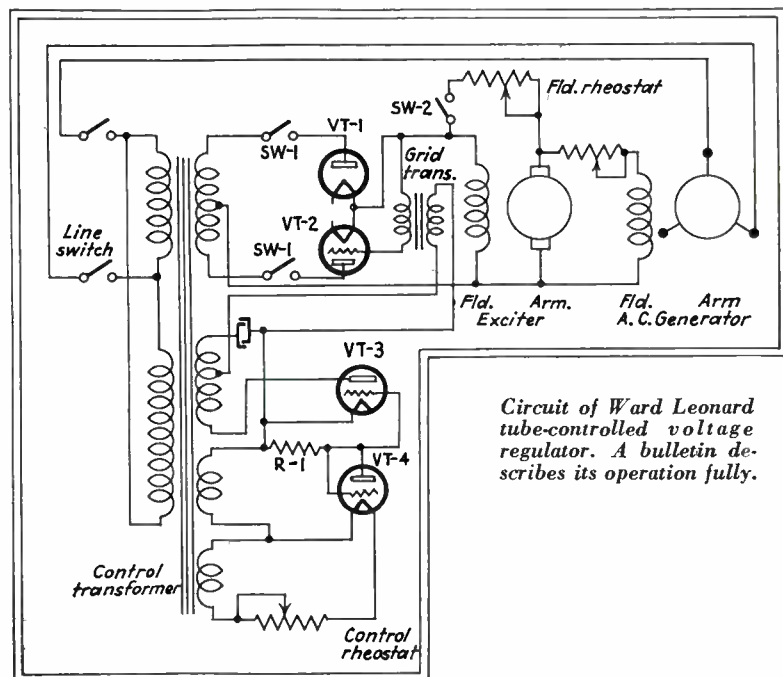

Circuit of Ward Leonard tube-controlled voltage regulator. A bulletin describes its operation fully.



MAINTAINING PRECISION QUALITY IN ELECTRICAL MEASURING INSTRUMENTS



**Model 521
Volt Ohm Milliammeter**
This five inch model is just one
of the many styles and sizes
available.

Model 521 Volt-Ohm-Milliammeter
Accuracy guaranteed within 1%

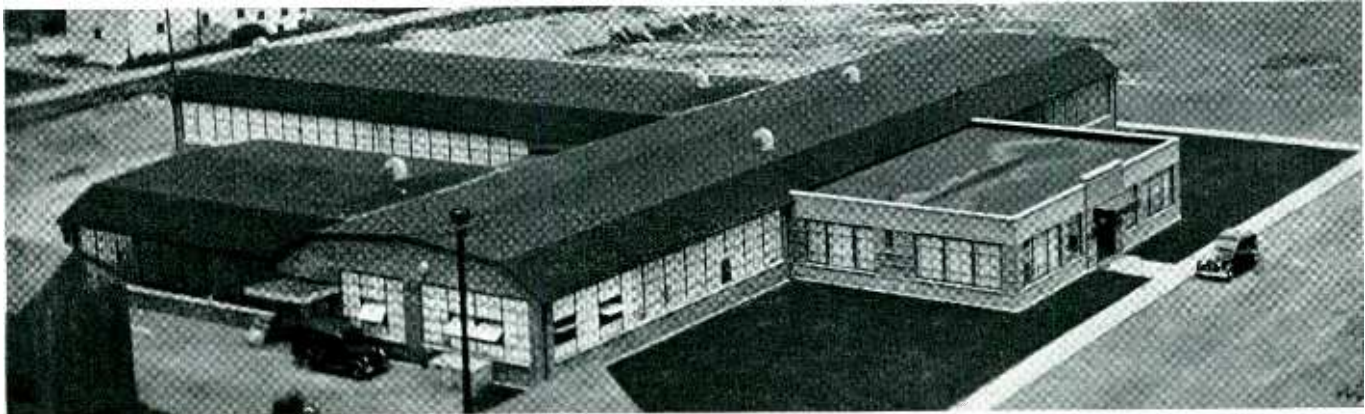

New TRIPLETT FACTORY, BLUFFTON, OHIO

This five inch model is just one of Triplet's large line of instruments manufactured on a quantity basis at attractive prices. Precision accuracy has been maintained through design improvements, highly efficient equipment, gauges and check methods by skilled labor working under ideal conditions in the new TRIPLETT FACTORY, BLUFFTON, OHIO.

Triplet Manufactures

a complete line of electrical measuring instruments embracing round, square, rectangular molded and metal cases, twin meters and multi range with changeable individual scales, for radio, electrical and general industrial applications. If you have an electrical instrument problem write to TRIPLETT.



INCORPORATES THESE NECESSARY AIDS FOR PRECISE INSTRUMENT MANUFACTURING

- DUST CONTROL
- TEMPERATURE REGULATION
- AIR CONDITIONING
- MANUFACTURING EQUIPMENT
NEW AND OF LATEST TYPE

MAIL THIS COUPON TODAY!

TRIPLETT ELECTRICAL INSTRUMENT CO.
238 Harmon Drive, Bluffton, Ohio, U. S. A.
Please send me at once—
More information on your Model 521.

NAME

ADDRESS

CITY.....STATE.....

GOAT

FORM FITTING TUBE SHIELDS

Make

GLASS TUBES and G-TUBES
"SELF SHIELDING TUBES"

GOAT RADIO TUBE PARTS, Inc., 314 Dean Street, Brooklyn, N. Y.



Literature

♦ **Sprink-la-stat Leaflet.** The Game-well Company, Newton, Massachusetts, describes its new automatic fire alarm system. Contains details on range of thermal ratings available and instruction for installation.

♦ **Amplifiers.** A booklet describing the complete line of preamplifiers offered by Audio Development Company, Minneapolis, Minnesota.

♦ **Instruments.** Leeds & Northrup Company's catalog No. N-33A, containing photographs, descriptions and maintenance data on Micromax thermocouple pyrometers.

♦ **Resistance Instruments.** Loose-leaf binder type catalog covering precision type resistance instruments and allied products (volume control attenuators, L, T and H pads, precision attenuators, volume indicators, etc.), published by Tech Laboratories, 703 Newark Avenue, Jersey City, New Jersey.

♦ **Transmitting Equipment.** Sheets picturing and describing transmitting condenser, modulation monitor, field strength indicator and antenna coupling units. Doolittle & Falknor, Inc., 1306 W. 74th Street, Chicago, Illinois.

♦ **Welding.** Specifications for Mallory dies, electrodes and water-cooled holders, contained in handy booklet for insertion in file. P. R. Mallory & Company, Inc., Indianapolis, Indiana.

♦ **Foote-Prints.** A booklet issued by the Foote Mineral Company, 16th & Summer Streets, Philadelphia, devoted to the history, properties and potential sources of Zircon.

♦ **Sound Recording.** A pamphlet issued by the Fairchild Aerial Camera Corporation, describing the Fairchild-Proctor studio recording system for broadcast stations. Woodside, New York City.

♦ **Photoelectric Apparatus.** Photocells, colorimeter, relays handled by Pfaltz & Bauer, Inc., designed by Dr. B. Lange, and described in pamphlets giving characteristics, uses, and internal views. Distributed by Pfaltz & Bauer, Inc., 300 Pearl Street, New York City.

♦ **Transformers.** Variac transformers for voltage control described by General Radio Company in a newly distributed pamphlet.

♦ **Industrial Control.** Ward Leonard Electric Company, Mount Vernon, New York, has issued a complete catalog with general descriptive material on their field rheostats, d-c and a-c manual starters, manual regulators, contactors, automatic starters and automatic transfer switches.

♦ **Calliflex.** Callite Products Company has published description of its new thermostatic bimetal, giving deflection formula and characteristics.

HEARST

Broadcasting Chain

INSTALLS



PRESTO

INSTANTANEOUS RECORDERS

Outstanding performance of the equipment, and not cost . . . was the final deciding factor in the selection of PRESTO INSTANTANEOUS RECORDING EQUIPMENT!

The inherent sturdy construction . . . High fidelity characteristics . . . Extreme portability . . . and lasting dependability in operation quickly demonstrated the money-making and money-saving possibilities of this equipment, to Hearst Engineers.

When time is not available for local talent . . . PRESTO RECORDERS will fill the breach by making the necessary recording. This recording can then be played back at any time.

Presto Green Seal Discs are available in all sizes for immediate delivery . . . All orders filled and shipped same day.

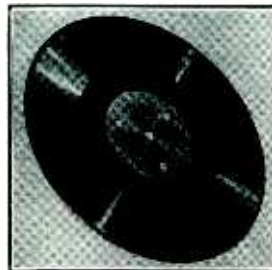

Technical assistance and complete descriptive literature gladly supplied on request.

At Presto Headquarters, you will find everything for your recording requirements . . . from a needle to a disc . . . to a complete high fidelity studio installation.

Export Division (except Australia and Canada)
M. SIMONS & SONS, INC.
25 Warren Street, New York
Cable: Simontrice, N. Y.

PRESTO

RECORDING CORPORATION

139 West 19th Street, New York, N. Y.

New Products

Small Metal-Can Electrolytic Condensers

A NEW SERIES of metal-can electrolytic condensers of large capacity is announced by the Aerovox Corp., 70 Washington St., Brooklyn, N. Y. The new condensers are uniform 1 in. diameter varying in height from $2\frac{3}{16}$ to $4\frac{3}{8}$ in., the latter being the 16 microfarad size. Two-voltage ratings, 450 and 250 d.c., are available. Capacities of 4, 8, 12 and 16 mfd. are offered. It is claimed that the capacity of these units is approximately twice that of the former units of equal size.

Cathode Ray Oscillograph and Accessory Units

ELECTROLAB, INC., of Bloomfield, N. J., announces type PR 100 oscillograph list price \$84.50. This cathode ray unit has a sweep oscillator capable of separating cycles from 6 to 1,000,000 cycles per second and a self-con-



tained amplifier. An electronic switch (type PR 200) for use with the cathode ray oscillograph permits simultaneous observation of any two recurring or transient phenomena; list price \$48.50. Type PR 300 direct coupled amplifier has controllable current and covers low frequencies up to 100,000 cycles, lists at \$34.50. Type PR 400 alternating current amplifier, also \$34.50, has an amplification of 1000 over the range between 10 cycles and 2,000,000 cycles.

Communications Attenuator

A NEW ATTENUATOR type "T-330" is announced by the Daven Co., 158-160 Summit Street, Newark, N. J. Attenuators are furnished with terminal impedances between 30 and 600 ohms, and listed at \$17.50. The attenuation is obtained in 30 steps with a standard range from approximately $1\frac{1}{2}$ db. to a total loss of 128 db., accuracy within 5 per cent and with no-frequency discrimination over the range from 30 to 17,000 cycles. Shipping weight is 22 oz. The diameter is $2\frac{3}{4}$ in. and depth back of panel $2\frac{1}{16}$ in.



A complete series of Cal-Lux Fluorescent Materials, fully tested, and of measured characteristics, is now available for the first time to the electronic industries.

Our electronic laboratory is fully equipped to furnish: spectral characteristics, rates of decay, and complete data on the response to Cathode Ray, X-Ray, Ultra-violet and Visible Radiations.

Write for full particulars

CAL-LUX FLUORESCENT MATERIALS

With Measured Characteristics For All Applications

CALLITE PRODUCTS DIVISION

EISLER ELECTRIC CORPORATION

544-39th STREET

UNION CITY, N. J.

PERFECT
LAMICOID
REG. U. S. PAT. OFF.

Engraving Stock #7025-#7031

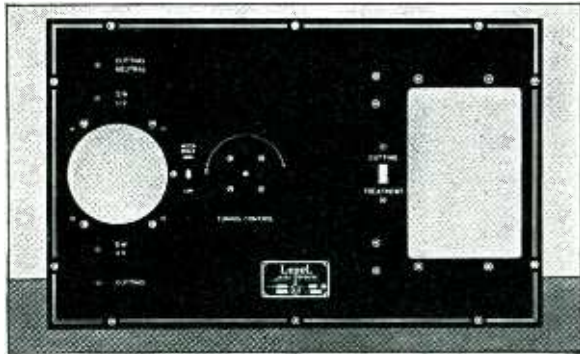

For Engraved Panels, Signs, Name Plates, Number Plates

Panel shown was fabricated by Insulating Fabricators, Inc., New York City, for the Lepel High Frequency Diathermy Machine. Made of a laminated sheet of Lamicoid #7025, having a pure white core and

lustrous black surface. Also available with white surface and black core, Lamicoid #7031. Engraved lettering is permanent, clean-cut, easily cleaned. Engraving stock furnished in glossy or satin finish.

MICA INSULATOR COMPANY

200 Varick St., New York; 542 So. Dearborn St., Chicago; 1276 West Third St., Cleveland.
Branches at: Birmingham, Boston, Cincinnati, Los Angeles, San Francisco, Seattle, Montreal, Toronto.



Insulated Wire . . .

Whether it requires a Simple Free Push Back or a Line Cord in Rubber or Silk—or even a multiple cable—Thousands of manufacturers depend on us for their production.

Write us for quotations.

General Sales Office

GENERAL INSULATED WIRE CORP.
53 PARK PLACE, NEW YORK CITY

TELEVISION? SOUND? INDUSTRIAL?



Whatever your interest may be in photo cells—there is a dependable super-sensitive CETRON available for most purposes.

As specialists in the manufacture of photo cells we are prepared to supply a wide range of standard cells or, if you prefer, we will make them to your specifications.

We invite your inquiry.

CONTINENTAL ELECTRIC CO.
ST. CHARLES 7 ILLINOIS

Wave Trap

ALADDIN RADIO INDUSTRIES, 466 West Superior Street, Chicago, Illinois, announce several new products. One prevents code interference from commercial ship-to-shore stations. This wave-trap is tuned by the movement of a magnetic core made of "Polyiron". It lists at \$2.50 with shield. Another

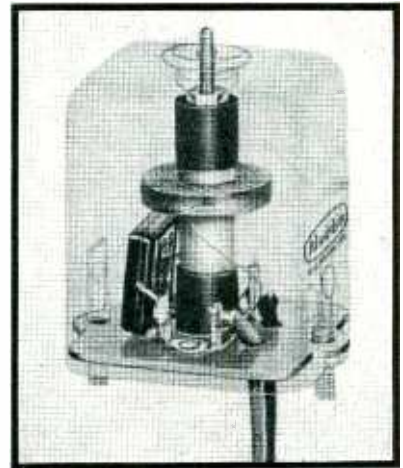

item is a type P, i-f transformer, in which the cores are adjustable with a screw thread and the inductance values are not affected by vibration, humidity or temperature changes. Fixed sealed condensers are permanently connected across the inductors. Type P transformers are characterized by high gain and a narrow band width. The third item is the type D-101 selective band three-circuit i-f transformer. Contained in an aluminum shield can 2" x 2" by 4", the transformer has three trimmer condensers, a link-mechanism so that selectivity may be adjusted.

Twin Multimeter

RAWSON ELECTRICAL INSTRUMENT COMPANY, INC., Cambridge, Massachusetts, has developed a new twin multimeter. This instrument combines the older type 501 D-C multimeter and type 502 thermal multimeter into one compact unit. This is accomplished by the use of a single movement switched from one side to the other without disturbing either circuit. Each side is well insulated from the other and the range shunts or voltage series resistors remain in circuit to the individual binding post, independent of the position of change-over switch. The scale is easily readable. Eight millivolts are dissipated on the approximately 10 ohms resistance of the junction and eight on the 10 ohm resistance of the meter circuit. The resistance of 10 ohms is constant on both the two and ten millivolt ranges, permitting correct overlapping of scale.

Literature

♦ **Time switches.** Zenith Electric Company, 607 S. Dearborn Street, Chicago, Illinois, announce several bulletins. Among these are Bulletin 702A describing remote control switches and magnetic contactors. Bulletin 500 describes automatic time switches and high amperage time switches. Bulletin 780 covers automatic reset timers; 780C automatic timers that are manually reset and 780B motor driven automatic timers.

♦ **P. A. Amplifiers.** Wholesale Radio Service, 100 Sixth Avenue, New York City, has published a catalog describing the complete line of 1936 Lafayette public address amplifiers, systems and accessories. Copies may be obtained by request addressed to the above address.

♦ **Sound Apparatus.** Leaflets "Sound Advice" describing various types of audio frequency equipment, pick-ups, turntables, etc. for recording and reproducing. Issued by the Sound Apparatus Co., 150 West 46th St., New York City.

♦ **Wax Recording.** "A Treatise on Practical Wax Recording," by Everette K. Barnes. Issued by Universal Microphone Co., Ltd., Inglewood, Calif. Price 50 cents. A 35-page booklet describing methods and apparatus used in modern wax disk recording technique.

♦ **Insulating Varnish.** A catalog describing the complete line of Irvington insulating varnishes. Also a folder describing Harvel 512C, an insulating varnish for coil windings, manufactured under Harvel patent, by Irvington Varnish & Insulator Co., Irvington, N. J.

♦ **Welding Apparatus.** "Electric Welding Machines and Welding Tips," a 64-page reference book (36-W) on resistance welding published by Charles Eisler of the Eisler Engineering Co., 750 So. 13th St., Newark, N. J. Available upon request to those interested in using resistance welding apparatus.

♦ **Laboratory Instruments.** "Galvanometers and Dynamometers," Catalog ED 1936, issued by the Leeds & Northrup Co., Philadelphia, Pa., including a description of several newly developed instruments, a narrow-coil galvanometer of high voltage sensitivity with a short period, and a dual galvanometer. The specifications and listings of all instruments have been brought up to date throughout the catalog. Obtainable upon request from Leeds & Northrup Co., 4934 Stanton Ave., Philadelphia, Pa.

A modern PLATE-SUPPLY TRANSFORMER



for **Broadcast
Station
Service**

by 

AmerTran Type RS plate-supply transformer. These units are of the oil-immersed type and are furnished in standard steel tanks. High-voltage bushings through cover; low-voltage leads through bushings in corner pocket; tap-changer operating handle through front of case; available in sizes from 1½ to 100 Kva., single phase or three phase.

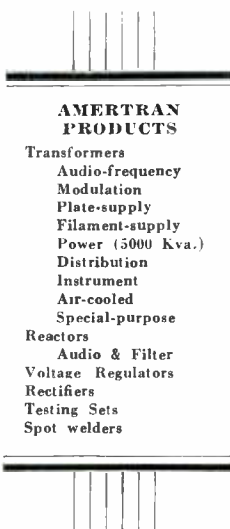

AMERTRAN PRODUCTS

Transformers
Audio-frequency
Modulation
Plate-supply
Filament-supply
Power (5000 Kva.)
Distribution
Instrument
Air-cooled
Special-purpose
Reactors
Audio & Filter
Voltage Regulators
Rectifiers
Testing Sets
Spot welders

WHETHER you require plate transformers and reactors for a small rectifier or a 500-kw. broadcast transmitter, AmerTran can furnish proper equipment of latest design. Transformers of either air-insulated or oil-immersed construction are assembled from standard stock parts, thus insuring quicker delivery, lower cost, and proved dependability.

The standard plate transformer illustrated is typical of oil-immersed rectifier equipment furnished to many broadcasting stations. Features include: coils vacuum impregnated in varnish, ample oil ducts for proper cooling and high overload capacity; syphonproof bushings of coordinated flashover type; tanks of weather-proof, splashproof construction which may be shipped filled with oil.

May we send engineering details of equipment to meet your requirements?

AMERTRAN
QUALITY TRANSFORMERS SINCE 1901
American Transformer Company Newark N.J. U.S.A.

Sales Offices: Boston, Chicago, Cleveland, Council Bluffs, Dallas, Hartford, Ithaca, Knoxville, Los Angeles, Montreal, Newark, New York City, Philadelphia, Pittsburgh, San Francisco, Seattle, St. Louis.

Now—
a high-powered—

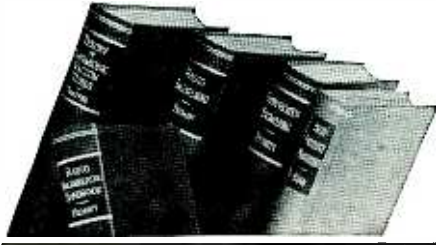

RADIO ENGINEERING LIBRARY

- especially selected by radio specialists of McGraw-Hill publications
- to give most complete, dependable coverage of facts needed by all whose fields are grounded on radio fundamentals
- available at a special price and terms

These books cover circuit phenomena, tube theory, networks, measurements, and other subjects—give specialized treatment of all fields of practical design and application. They are books of recognized position in the literature—books you will refer to and be referred to often. If you are a researcher or experimenter—if your interest in radio is deep-set and based on a real desire to go further in this field—you want these books for the help they give in hundreds of problems throughout the whole field of radio engineering.

5 volumes, 2981 pages, 2000 illustrations

1. Everitt's COMMUNICATION ENGINEERING
2. Terman's RADIO ENGINEERING
3. Chaffee's THEORY OF THERMIONIC VACUUM TUBES
4. Hund's HIGH-FREQUENCY MEASUREMENTS
5. Henney's RADIO ENGINEERING HANDBOOK

Special Low Price and Easy Terms

Bought singly, the five volumes comprising this library would cost you \$26.00. Under this offer you save \$2.50 and, in addition, have the privilege of paying in easy installments beginning with \$2.50, 10 days after receipt of the books, and \$3.00 monthly thereafter. Already these books are recognized as standard works that you are bound to require sooner or later. Take advantage of these convenient terms to add them to your library now.

SEND THIS ON-APPROVAL COUPON
McGraw-Hill Book Co., Inc.
330 W. 42nd St., New York, N. Y.

Send me Radio Engineering Library 5 vols., for 10 days' examination on approval. In 10 days I will send \$2.50, plus few cents postage, and \$3.00 monthly till \$23.50 is paid, or return book, postpaid. (We pay postage on orders accompanied by remittance of first installment.)

Name

Address

City and State

Position

Company L.8-36

(Books sent on approval in U. S. and Canada only.)

Broadcast Pre-Amplifier

A PRE-AMPLIFIER, type AR-83, designed for use with dynamic and velocity types of microphones in high-fidelity transmission is announced by the Techna Corp., 926 Howard St., San Francisco. The unit is a two stage, resistance-coupled, fixed gain (44 db.) and the frequency response is within ± 1 db. from 30 to 12,000 cycles, with harmonic content of less than 1% at zero level. Input and output transformers to match 30 or 250 ohm lines. Panel size $5\frac{1}{4}$ in. x 19 in. Net price \$67.50. A power supply furnishing 180 to 250 volts of highly filtered d-c for plate current at a total of 17 milliamperes and 6.3 volts filament voltage for operation of up to six AR-83 units is also available at a price of \$58.00.

• • •

Velotron Microphone

THE BRUNO LABORATORIES, INC., 20 West 22nd Street, New York City, announce the Velotron Microphone, a new velocity microphone incorporating entirely new principals of construction and employing a static rather than a magnetic field. The output is very much higher than that of the conventional magnetic velocity microphone being on the order of -53 db. It is a high impedance microphone but may be employed with cable lengths up to 500', without detriment to the quality of the output. It maintains its high fidelity characteristics even under close talking conditions. It has approximately the same directional characteristics as the magnetic velocity microphone but the angle of pickup is some degrees wider. It is rugged, dependable, and unaffected by temperature and atmospheric conditions. Comes equipped with a shock absorber, swivel, and cable connector. Finished in gunmetal. Weight 1 lb., overall measurements $6\frac{1}{4}$ " x $2\frac{1}{4}$ " x $1\frac{3}{4}$ ". List price \$20.00. Twenty-five-foot cable and carrying bag.

• • •

"Super Pro"

HAMMERLUND MANUFACTURING COMPANY, 424 West 33rd. Street, New York City, has just developed a sixteen tube superheterodyne for the professional and amateur operator. This "Super Pro" model covers from 540 kc. to 20 mc. by means of 25 coils. It has an electrostatically shielded input, variable selectivity, high fidelity, variable beat oscillator, tone control and other circuit features.

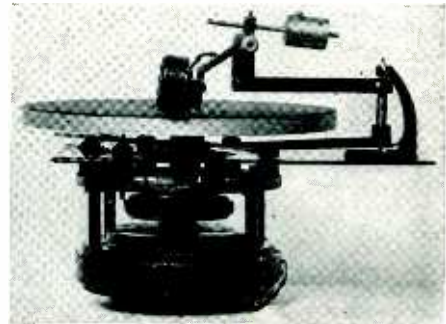

Saja recording unit using Saja Motor

SAJA MOTOR

"Saja Synchronous Motors" designed for high quality disc recording and reproducing High Torque—no vibration—constant speed—sturdy symmetrical construction. No gears in either single or dual speed motors. *Dual speed motors* change speed electrically.

DURALOTONE DISCS

HIGH LEVEL RECORDING—WIDE FREQUENCY RANGE—MORE DURABLE THAN PRESSINGS—PLAYBACK WITH REGULAR STEEL NEEDLES.

Write for literature

SOUND APPARATUS COMPANY
150 West 46th St. New York, N. Y.

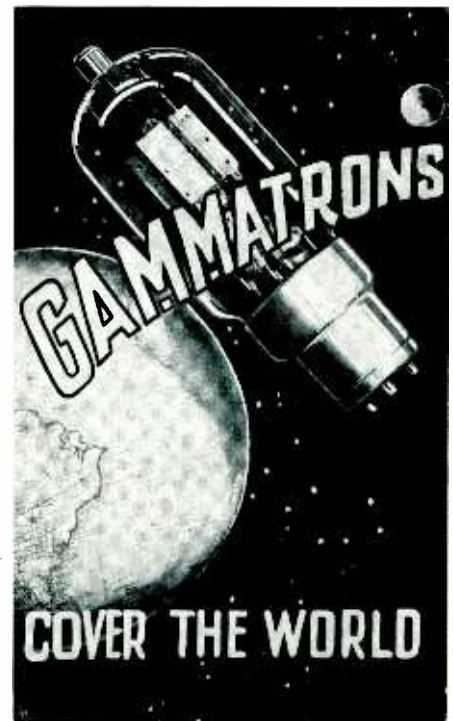

WRITE FOR OUR ENGINEERING TUBE FOLDER
NO. 102

HEINTZ AND KAUFMAN
SOUTH SAN FRANCISCO LTD CALIFORNIA U. S. A.

Relay

AMERICAN GAS ACCUMULATOR COMPANY, Elizabeth, New Jersey, has a new time delay relay designed for use in conjunction with any electrical apparatus requiring a delay interval. It has a delay range from a fraction of a second to several minutes. The design of the timing head is based on 25 years of experience. A volume of gas is maintained in the timing head by two special diaphragms which are made from the same special type of leather that has been used in the AGA flashing marine lighthouses. This unit is unaffected by dust, temperature or humidity changes. The timing period is unaffected by fluctuations of voltage.

Attenuator

A NEW ATTENUATOR of improved design is announced by the Tech Laboratories, 703 Newark Avenue, Jersey City, N. J. This new unit is especially designed for broadcast and high grade



sound recording purposes. It has a larger number of steps, lower noise level, better frequency characteristics, better terminals, easier wiring and smoother operation.

Controlled Rectifiers

WARD LEONARD ELECTRIC COMPANY, Mount Vernon, New York, has announced a new line of controlled rectifiers providing d-c power, from an a-c power supply for small public and private telephone systems. This equipment on an a-c line varying ± 10 per cent, supplies a d-c voltage maintained constant to $\pm 1\frac{1}{2}$ -volt accuracy from no load to full load. In locations where the a-c power supply is not continuously available and uninterrupted telephone service is necessary, a standby battery of proper voltage with emergency ampere-hour rating should be used. This unit consists of a Hysterset, rectifier and filter units assembled in a metal enclosure and arranged for floor mounting. Both sizes are equipped with suitable d-c voltmeter and ammeter.

ELECTRONICS—August 1936

BRUSH *Spherical* MICROPHONE



● A specially designed, general purpose microphone for remote pickup, "P. A." and commercial interstation transmission work. Low in price . . . but built to Brush's traditionally high mechanical and electrical standards. Wide frequency response. Non-directional. No diaphragms. No distortion from close speaking. Trouble-free operation. No button current and no input transformer to cause hum. Beautifully finished in dull chromium. Size only $2\frac{1}{8}$ inches in diameter. Weight 5 oz. Output level minus 66 D. B. Locking type plug and socket connector for either suspension or stand mounting furnished at no extra cost. Full details, Data Sheet No. 13. Free. Send for one.

BRUSH *Lapel* MICROPHONE



● For after dinner and convention speakers, lecturers, etc. Gives great mobility — the smallest, lightest microphone on the market. Size $1\frac{1}{2} \times 1\frac{1}{4} \times \frac{3}{8}$. Weight with coat attachment less than 1 oz. Special internal construction and rubber jacketed outer case insures quiet operation. No interference from breathing noises, etc. Typical Brush sound cell response and trouble-free operation. Details on request.

The **BRUSH** DEVELOPMENT COMPANY
PIEZO ELECTRIC
1884 E. 40th St. CLEVELAND, O.

MICROPHONES • MIKE STANDS • TWEETERS • HEAD PHONES • LOUD SPEAKERS

VULCOID

an adaptable material

Vulcoid is a chemically processed, laminated, fibrous insulating material that is permanently moisture resistant—adaptable for many insulating requirements—readily machined, and formed by heating.

PROPERTIES

	THICKNESS			
	1/16"	1/8"	3/16"	1/4"
Specific Gravity.....	1.40	1.40	1.40	1.40
Average Flexural Strength Pounds per Square Inch.....	23,000	21,000	20,000	19,000
Average Tensile Strength Pounds per Square Inch.....	11,000	11,000	10,000	9,000
Dielectric Strength Volts per Mil	500	450	350	300

Vulcoid is a comparatively low cost non-hygroscopic material, economical to buy in sheet, rod or tube form, economical to fabricate, stable in both electrical and mechanical properties. Ask for complete information.

CONTINENTAL-DIAMOND FIBRE COMPANY

NEWARK, DELAWARE

FAIRCHILD PROCTOR

CRYSTAL PICKUP



Ideal for modern transcriptions

Assures uniform response, extended high and low frequency range, minimum record wear. Is non-resonant, non-magnetic, and freely damped. Calibrated needle pressure scale. Sturdy design and construction. Write for Circular E-1.

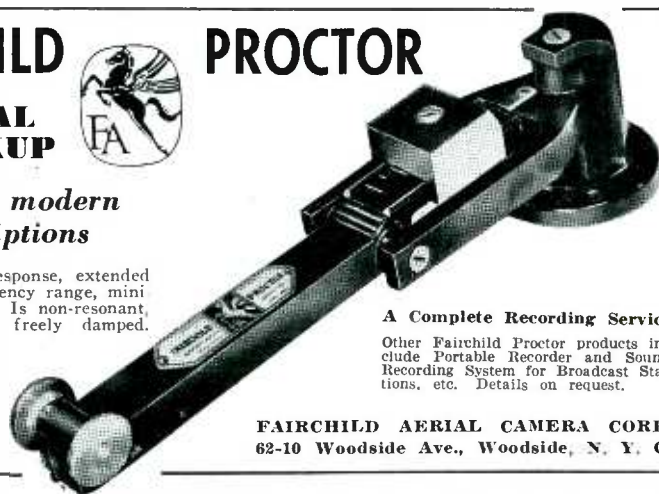

A Complete Recording Service

Other Fairchild-Proctor products include Portable Recorder and Sound Recording System for Broadcast Stations, etc. Details on request.

FAIRCHILD AERIAL CAMERA CORP.
62-10 Woodside Ave., Woodside, N. Y. C.

DYNAMIC MICROPHONES



ARE INCREASING IN POPULARITY *because they*

- have greater sensitivity
- are free from inductive pickup
- have no background noise
- can work with long lines
- are sturdiest ever produced
- are weatherproof
- are small in size
- are reasonable in price

Write for Bulletin No. 3012

RADIO RECEPTOR COMPANY, INC.
108 SEVENTH AVE. NEW YORK, N. Y.

An Ideal Midget RESISTOR

for analyzer, meter conversion, etc.



The Type "R" MICROHM meets the popular demand for a compact, low priced Resistor. While small in size, it is of high quality and accurate to within 1%. The Type "R" is 1/2-watt, with resistance up to 500,000 ohms. As a companion unit, we offer the type "S", 1-watt, which is available in resistance values up to 1 megohm. Write for details.

MICROHM

WIRE WOUND RESISTORS

PRECISION REGISTOR CO., 334 Badger Ave., Newark, N. J.

LEACH LR RELAYS

you can depend upon their
OPERATING RELIABILITY



TYPE NO. 1357

Leach small size circuit control relay, type No. 1357 is a compact, rugged and reliable control relay ideal for your control circuit. These relays have solid cores, positive contact and low current consumption—built so that you can depend upon them!

LEACH RELAY COMPANY
5915 Avalon Boulevard, LOS ANGELES, CALIF.

LEACH RELAY COMPANY, 5915 Avalon Boulevard, Los Angeles, Calif.

Please send your catalog. I am interested in.....type relay.

Name
Company
AddressCity

News

†The New York Office of the Allen-Bradley Co., manufacturers of motor control equipment and resistors has been moved to larger quarters in the Underwood Building, at 30 Vesey St., from the former location at 50 Church St. A complete consignment stock of motor control equipment will be carried in the new headquarters.

†Ira J. Owen, well-known industrial engineer, has been named president of the Utah Radio Products Co. to succeed J. W. Caswell, who continues as director. Mr. Owen, a graduate of Cornell University, has been a consulting engineer for several years.

†Edward J. McCarthy has been appointed to the position of general sales manager of The Gamewell Co., according to an announcement of Mr. Vincent C. Stanley, president, Mr. McCarthy has been in the employ of The Gamewell Co. for over 16 years, joining the Gamewell Co. in 1920 after his graduation from Massachusetts Institute of Technology.

†Mr. H. J. Casey, manager of the Republic Radio Mfg. Co., announces the removal of their factory and general sales offices to larger manufacturing facilities at 255 Grant Ave., East Newark, N. J. Licensed manufacturers of radio tubes.

Literature

†Pickup. Fairchild-Proctor's wide range, high fidelity crystal pickup described in a pamphlet issued by the Fairchild Aerial Camera Corporation, Woodside Avenue, Woodside, New York City.

†Amplifiers. A new 48 page bulletin including data and circuits on amplifiers from one half watt to 1,000 watts output, chapters on audio transformer design, charts on decibel conversion, reactance data, published by United Transformer Corporation, 72 Spring Street, New York City.

†Recording and Transcription. Presto Recording Corporation, 139 West 19th Street, New York City, has prepared a catalog describing in detail the latest developments in equipment, discs and parts, for instantaneous recording and transcription. Copies available upon request.

†Speakers. Catalog describing permanent magnet speakers for use in receiver, car and public address equipment, published by Cinaudagraph Corporation, Stamford, Connecticut.

Vacuum Type Thermo Couple

THE SENSITIVE RESEARCH INSTRUMENT CORP., 4545 Bronx Blvd., New York City, announces a new type of thermocouple mounted in a highly evacuated glass bulb, suitable for measurement of any d.c. or a.c. current of any frequency, including radio frequency. The thermo couples are mounted in a molded Bakelite base or can be supplied with a standard U tube base or unmounted. Other new items are announced in "Electrical Measurements," for April 1936, a house bulletin issued by the company.

Sensitive Research has also added to its Polyrange instrument group a dynamometer current and voltage measuring instrument which measures a-c currents and voltages from 2 ma. to 10 amperes and from 2 volts to 3000 volts with an accuracy of $\frac{1}{4}$ of 1% at commercial frequencies.

Relay Equipment

STRUTHERS-DUNN INC., 139 North Juniper St., Philadelphia, Pennsylvania announce a relay equipment for the control of crystal ovens. This equipment consists of a sensitive relay and front contact relay. The thermoregulator controls the coil of the sensitive relay whose contact in turn controls the coil of the front contact relay. The contact of the front contact relay controls the heating circuits, so that the contacts of the thermoregulator need only carry a current of a few milliamperes to control the load circuit. The load contacts are 6 amperes at 110 volts, a.c. for heating loads. This equipment sells at \$20.90 including the glass cover. The relays are mounted on a base 7 in. high by 5 in. wide under a glass cover which is $3\frac{3}{8}$ inches high.

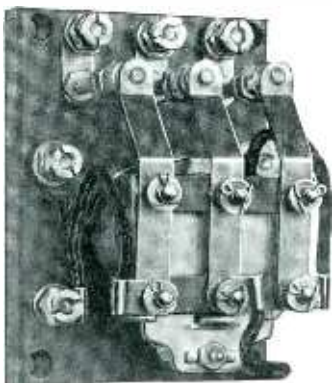

Several motor operated timing devices have been added to the Struthers-Dunn, Inc. line of thermo, inertia, air dashpot and capacitor times. One type is of the immediately recycling type; another is of the continuously rotating type.



Model 14C Standard Signal Generator

An instrument for research and design laboratory use

IMPORTANT FEATURES:

Built in coils cover 75 to 30,000 kilocycles . . . Output up to TWO VOLTS across LOW RESISTANCE. (Never over 20 ohms) . . . Worm drive condenser with 30 FOOT scale length (10 kilocycles in broadcast band = 25 large scale divisions) . . . Operates on either 115 volt 60 cycle AC or batteries (Without change in instrument) . . . Low radio frequency harmonics. (Approximately one per cent)

Price, \$1250.00 F.O.B. Newark, N. J. Write for illustrated circular with full details.

FERRIS INSTRUMENT CORPORATION
BOONTON, N. J.

Featuring A BASICALLY NEW SWEEP AND AN IMPROVED SYNCHRONIZING CIRCUIT THE MODEL 148 CATHODE RAY OSCILLOGRAPH

This new oscillograph utilizing a five inch cathode ray tube incorporates many advanced features, developed by DuMont, and offered for the first time in a commercial unit.

Improvements are such as to assure ease of operation and accurate determinations. A basically new sweep circuit permits observation of waves from 10 to 500,000 cycles per second. A speeded up return trace which does not interfere with the pattern at high frequencies is another exclusive feature. Sweep can be synchronized easily with fractions as well as multiples of the wave.

Amplifiers are arranged so that they may be used either as single stage for each set of deflection plates or as two stage for vertical deflection plates.

Signal and sweep voltages in various combinations can be applied easily and conveniently by a single knob control. A calibrated scale is supplied for highly accurate determinations when used with a five inch cathode ray tube. Completely AC operated from 110-120 volt supply.

Full technical data and the wide field of uses for which this instrument may be effectively applied will be sent on request.



List Price with 5" tube \$106.50

DuMont also manufactures an improved and simplified Electronic Switch and other Oscillograph equipment as well as a complete line of cathode ray and sweep discharge tubes. These products are in the sixth year of successful manufacture.

Every Cathode Ray Tube used by DuMont is engineered and manufactured in the DuMont Laboratories. Write for full information.

ALLEN B. DUMONT LABS. INC., UPPER MONTCLAIR, N. J.

Announcing THE SIGMA SENSITIVE RELAY



Jewelled movement.
Balanced to operate in any position.
Positive operation on 4 milliwatts, D. C.
Single pole, double throw.
Mounts in standard 5-prong tube socket.
A useful adjunct to
V. T. controls
Supervisory and alarm circuits
Signalling.

**SIGMA INSTRUMENTS,
INC.**

388 Trapelo Road, BELMONT, MASS.



Better Filtering for Midget sets



Three entirely independent sections in compact can, hermetically sealed for longest trouble-proof life—that's the idea of the new Series GGGL electrolytics. Six leads—two for each section. Units measure 1 3/4" dia. x 3 3/4" or 4 1/4" high. Inverted mounting. Two ratings—250 and 450 v. working. In 4-4-4, 8-8-8, 8-8-16 and 8-16-16 mfd. combinations. Handy 3-in-1 electrolytics for better filtering in tight places.

★ Write for new catalog covering complete line of condensers and resistors. Submit problems for engineering aid and quotations.

AEROVOX

CORPORATION

75 Washington St. Brooklyn, N. Y.

Audio Frequency Meter

GENERAL RADIO COMPANY, 30 State Street, Cambridge, Massachusetts, announces the electronic frequency meter, Type 834-A, a time-saving aid in frequency measurements. The instrument includes a one-stage amplifier, the gas-discharge-tube counter circuit, diode switching tube, frequency-indicating meter and power supply (with rectifier and voltage regulator). By arrangement of the amplifier circuit provision is made for satisfactory operation over a wide range of signal input voltages up to 200 volts, with no change in indication of frequency. Five ranges are provided, starting at zero and extending to 200, 500, 1,000, 2,000 and 5,000 cycles.

The June issue of the Experimenter describes the new 605-A signal generator covering a range of 9.5 to 30,000 kc. Designed by Messrs. E. Karplus, L. B. Arguimbau and A. G. Bousquet.

Low Cost Microphone

A DOUBLE-BUTTON carbon microphone for which exceptional performance and durability is claimed has been announced by the Shure Bros., 215 West Huron St., Chicago, U. S. A. The list price is \$5.50. The model is flat within \pm 10 db. from 40 to 6000 cycles per second with a maximum button current of 12 milliamperes. The output level is 30 db. below 6 mw. in 200 ohms.

Shure Brothers also announce a new four-way utility microphone, for desk, direct stand, hand or ring use.

Plastics

GENERAL PLASTICS, INC., North Tonawanda, New York, announces a new line of resins by which wood, pulp and cellulose materials in many forms can be strengthened and given greater resistance to acids, solvents, and alkalis. A new extra strength Durex molding material known as 15/44 has been announced. It has higher impact strength, is light in weight and has good machining qualities. Still other new products are improved thermosetting resin solutions for impregnation and coating of motor and generator armatures. Furthermore, metal castings may be impregnated with these resins to reduce poracity.

Door Alarm

BY MEANS of the Photobell Model L electric eye signal any one entering a store or office door cuts a beam of light and rings a bell or chimes. The device can be used as a burglar alarm or an attention caller. It is good for distances up to 15 feet, costs one cent a day for electricity, is guaranteed for six months, lists at \$49.00. Phorobell Corporation, 96 Warren Street, New York City.

PROFESSIONAL SERVICES

ISABEL S. BEMIS MATHEMATICAL SOLUTIONS Radio Engineering Problems

Fifteen years experience covering.
Calculation of Directive Antenna Diagrams, Analysis of Radio Field Intensity Data. Broadcast Coverage and Population Studies. Harmonic Analysis of Curves. General Statistical Work.
431 N. Walnut St., East Orange, N. J.

BLILEY ELECTRIC CO.

Designers—Manufacturers
Quartz Crystals for standard or special radio frequency applications.
Inquiries Invited.
240 Union Station Bldg.
Erie, Penna.

EISLER ENGINEERING CO.

Consulting, Designing & Mfg. Engineers
Electric Welding Problems, High Compound Vacuum Pumps, Soft and Hard Glass Working Equipment, Radio and Electronic Tube Machinery
Special Machinery built to your specifications
753 So. 13th St. Newark, N. J.

ELECTRICAL TESTING LABORATORIES

Characteristics and
Life Tests of Vacuum Tubes
Tests of photo cells, glow lamps, crater lamps.
Tests of electronic and optical devices.
80th Street and East End Avenue
New York, N. Y.
Phone: Butterfield 8-2600

BERNARD EPHRAIM, E. E.

Expert Foreign Technical Translator
Patent Specifications Engineering Articles
French, Spanish, Italian, German
Box 4049, San Francisco, California

THAD R. GOLDSBOROUGH

REGISTERED PATENT ATTORNEY
Westinghouse Electric, 1925-1930
Patent Attorney, RCA Victor, 1930-1935
Fifteen years familiarity with patent matters relating to Talking Movies, Television, Radio and Electronics.
201-205 McLachlen Building
Washington, D. C.

HUDSON BROS. MFG. CO., Inc.

539-41 42nd St., Union City, N. J.
Designers and consultants for experimental glass apparatus, pyrex and soft glass.
Aspirator Pumps Ground Joints
Graded Seals Stop-Cock Grease
Stop-Cocks Pyrex and McLeod Gauges
Soft Glass Traps of all types.
Glass Apparatus Made to Blue Print Specifications.
Tel. Fallsade 6-2940

PROFESSIONAL ASSISTANCE

in the solving of your most difficult problems in the highly specialized field of electronic devices is offered by consultants whose cards appear on this page.

PATENTS REVIEW

PATENTS indicate trends. Next year's radio circuits, applications of electron tubes for non-communication purposes, new tube types, new materials, may be discovered by following United States and British inventions.

Transmission Circuits

Transmission line. Method of preventing standing waves on a portion of a transmission line by determining the ratio of the maximum and minimum standing wave amplitudes and connecting a pure reactance across the line at a maximum current point, the value of the reactance depending upon the ratio across the line at a point at a distance from the ascertained current maximum point dependent upon the ratio and less than an eighth of a wave length. P. H. Smith, B.T.L., Inc. No. 2,041,378.

Modulation circuits. The following patents are on the general subject of modulation: No. 2,038,992, J. G. Chaffee, B.T.L., Inc., ultra short wave system. No. 2,033,231, M. G. Crosby, RCA, phase modulation. No. 2,034,899, W. T. Ditcham, RCA, modulated transmitter. See also No. 2,038,526, to Ditcham. No. 2,037,756, Otto Böhm and M. Osnos, Telefunken, modulation system. No. 2,042,748, G. L. Usselman, RCA, modulating means. No. 2,043,255, W. S. Marks, Jr., Fort Monmouth, N. J., screen grid modulation.

Synchronizing system. A common frequency broadcasting system, C. B. Aiken. No. 2,033,271. B.T.L., Inc.

Ring circuit. No. 2,023,222, G. W. Fyler, G.E.Co., on a ringing circuit for radio-transmitters.

Duplex transmission. A duplex signaling system comprising a super-regenerative receiver at each end for reception. E. H. Armstrong, New York, N. Y. No. 2,024,138.

Airplane transmitter. No. 2,022,049, L. J. Lesh, Associated Electric Laboratories, Inc.

Frequency control. No. 2,026,382, A. Frum, Telefunken. Means for periodically checking the frequency of a transmitter by means of a photo-electric cell, etc.

Broadcasting system. Multi-channel high frequency wire-broadcasting system. P. P. Eckersley, London. No. 2,031,528. See also No. 2,030,948 to J. L. Weston, Wired Radio, Inc., on a method of transmitting signal-

ing electrical energy over commercial electrical power network.

Signaling system. No. 2,041,830, C. W. Hansell, RCA, on a high frequency transmitter involving a magnetron oscillator.

Duplex system. Separate antennas for transmission and reception, the antennas displaced from each other so that the receiving antenna is in the shadow of the transmitting antenna at the same terminus. A. G. Clavier and R. H. Darbord, W.E.Co. No. 2,043,347.

Printing system. A combination of commercial telegraph printers in a radio telegraph system. W. C. Hill, Grand Island, Nebr. No. 2,017,458.

Fading reduction. Modulating the waves to a depth which varies exponentially as the amplitude of the modulating potential varies. H. O. Roosenstein, Telefunken. No. 2,031,072.

Carrier suppression. Combination with an electric wave filter including a piezo-electric crystal of mechanical means for controllably damping the vibration of the crystal whereby its sharpness may be reduced. H. O. Roosenstein, Telefunken. No. 2,035,013.

Antenna Systems

Reflector. Unitary continuous reflecting web of curvilinear profile devoid of salients partly enclosing the source of energy. The web is made of an inherently highly resilient material. Rene Jean Le Guillou, Paris, France, assigned Societe des Applications "Guilux." No. 2,032,622.

Duplex antenna. System for short and long wave reception comprising an antenna, a pair of downlead conductors, transformers, etc. E. V. Amy and J. G. Aceves, reissue 19,854.

Relaying system. A repeating station having a reflector in a plane at an angle with respect to the horizontal, another reflector in a plane at an angle with respect to the horizontal and inclined with respect to the first named plane, a parabolic reflector, etc. S. G. Frantz and J. Q. Stewart, RCA. No. 2,042,302.

Beam system. Reversible unidirectional antenna comprising two radiating elements, one of the elements having a two wire line connected thereto, and a switching mechanism in circuit for shunting out a portion of the line for reversing the direction of radiation. P. S. Carter, RCA. No. 2,040,079. See also No. 2,038,539 to Carter, RCA, on a directional system for radiation in two different directions differing by an angle which is less than 180 deg.

Antenna system. A bridge circuit involving a receiver, an antenna, a

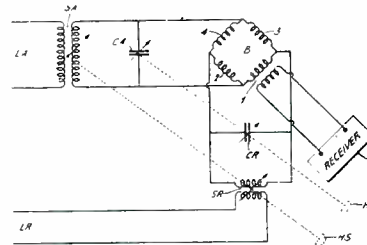

reflector and amplitude regulator. Wilhelm Moser, Telefunken. No. 2,033,390.

Multiple antenna system. A method of communication comprising energizing several paths of different lengths in the transmission medium between

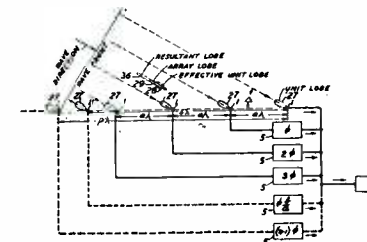

two stations and receiving at any one instant wave energy propagated along only one of the energized paths regardless of the proximity of the incoming energized paths. H. T. Friis, B.T.L., Inc. No. 2,041,600.

Amplifier Circuits, Etc.

Multi-element tube circuit. Combination in a vacuum tube of a diode element and an amplifier, whereby the signal may be amplified and rectified in a single tube. K. C. Black, RCA. Reissue No. 19,943.

Protective system. An incandescent lamp used as an overload prevention device, the lamp comprising a dial

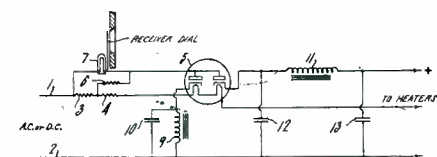

light. Nicholas Raskhodoff, United American Bosch. No. 2,043,676.

Noise suppressor. M. E. Bond, United American Bosch Corp., Springfield, Mass. No. 2,034,970. See also No. 2,034,974 to W. F. Cotter and M. E. Bond, Bosch, on an oscillator circuit.

Detector circuit. A detector having a fixed and a variable bias arranged so that its efficiency increases in response to an increase in the amplitude of an incoming wave. J. C. Warner, G.E. Co. No. 2,031,441.

Fidelity control. A detector followed by an a-f amplifier with a rising characteristic has a network such that

minimum selectivity is secured when a strong signal is received. G. V. Dowding, RCA. No. 2,031,034.

Patent Suits

1,403,475, H. D. Arnold, Vacuum tube circuit; 1,403,932, R. H. Wilson, Electron discharge device; 1,507,016, L. de Forest, Radio signaling system; 1,507,017, same, Wireless telegraph and telephone system; 1,618,017, F. Lowenstein, Wireless telegraph apparatus; 1,702,833, W. S. Lemmon, Electrical condenser; 1,811,095, H. J. Round, Thermionic amplifier and detector; Re. 18,579, Ballantine & Hull,

Demodulator and method of demodulation filed April 6, 1936, D. C., S. D. Calif. (Los Angeles), Doc. E 890-Y, *Radio Corp. of America et al. v. M. de Groot (Ambassador Radio Co.)*. Same filed April 7, 1936, D. C., S. D. Calif. (Los Angeles), Doc. E 892-Y, *Radio Corp. of America et al. v. R. A. Cottrell*. Doc. E 894-S, *Radio Corp. of America et al. v. E. Spiegel*.

1,573,374, P. A. Chamberlain, Radio condenser; 1,795,214, 1,707,617, E. W. Kellogg, Sound reproducing apparatus; 1,894,197, Rice & Kellogg, same; 1,728,879, same, Amplifying system, filed April 7, 1936, D. C., S. D. Calif. (Los Angeles), Doc. E 891-Y, *Radio Corp. of America et al. v. M. de Groot (Ambassador Radio Co.)*. Same, filed April 6, 1936, D. C., S. D. Calif. (Los Angeles), Doc. E 893-C, *Radio Corp. of America et al. v. R. A. Cottrell*. Doc. E 895-J, *Radio Corp. of America et al. v. E. Spiegel*.

1,811,095, H. J. Round, Thermionic amplifier and detector; Re. 18,579, Ballantine & Hull, Demodulator and method of demodulation; 1,297,188, I. Langmuir, System for amplifying variable currents, D. C. N. J., Doc. E 5261, *Radio Corp. of America et al. v. Atlas Laboratories, Inc.* et al. Decree referring to Master Mar. 2, 1936.

1,973,277, A. R. Barfield, Electroacoustic translating device, filed Feb. 17, 1936, D. C. Md., Doc. E 2432, *G. G. Cromartie et al. v. Montgomery Ward & Co.*



Frequency Measuring Service



Many stations find this exact measuring service of great value for routine observation of transmitter performance and for accurately calibrating their own monitors.

MEASUREMENTS WHEN YOU NEED THEM MOST

R.C.A. COMMUNICATIONS, Inc.

Commercial Dept.

A RADIO CORPORATION OF AMERICA SERVICE

66 BROAD STREET
NEW YORK, N. Y.

CLEEN-CUT

The **QUALITY BLANK** for Instantaneous and transcription recording is **STANDARD** with the foremost recording studios as well as with the largest and most discriminating users of recording blanks.

We recommend RECO-LUBE to further prolong the playing life of recordings made on CLEEN-CUT blanks.

Write for literature and price list.

ALLIED RECORDING PRODUCTS CO.

Phone BRyant 9-1435
126 West 46th Street, New York, N. Y.



PIONEER DYNAMOTORS

A Power Supply You Can **DEPEND** On!

NOW you can have a *better* power supply for Police, Air Craft, Marine Radio Service and Sound Systems! Pioneer "Silver Band" Dynamotors provide an unflinching—uniform—high voltage. They're not affected by vibration. They're compact, light weight and sturdily built! Sizes: 6 to 110 volts input and up to 1000 volts output. Write for full information!

Other Pioneer Products

PIONEER Red Seal Gen-E-Motors, Rotary Converters, "Blue Diamond" 110 V. 300 Watt AC Gas-Electric Power Plant, with DC winding for charging 6 volt batteries. Other Gas Electric Power Plants from 6 to 110 volts and 150 to 1500 watts, either AC or DC.

MAIL THIS COUPON NOW!

PIONEER GEN-E-MOTOR CORP.
464-X West Superior St., Chicago, Illinois

Mail literature Silver-Band Dynamotors, Gas Electric Plants, Converters, Gen-E-Motors.

Name

Address

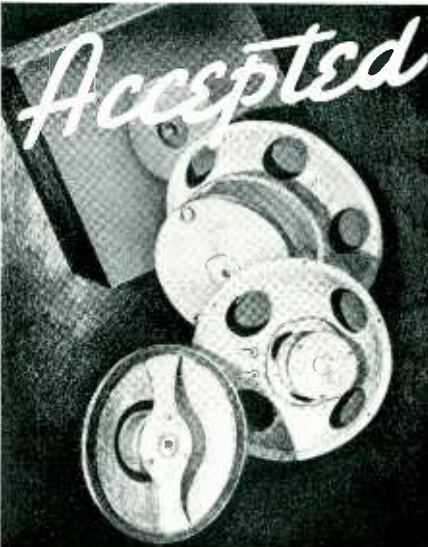

Accepted

LESS than a year has elapsed since Cinaudagraph introduced the **MAGIC MAGNET SPEAKER**. The revolutionary principles embodied in this fine speaker have definitely given it first place in the radio industry.

Engineers, manufacturers, assemblers of P.A. equipment, service technicians, have placed their stamp of unqualified approval on **MAGIC MAGNET SPEAKERS**.

Have your secretary request descriptive literature and engineering data . . . TODAY.

CINAUDAGRAPH CORPORATION
Speaker Division, Dept. "S" • Stamford, Conn.

CINAUDAGRAPH

Oscillation circuits. The following patents are on the general subject of oscillation generation: No. 2,039,118, Kurt Schlesinger, Berlin, on a tilting oscillation generator. See also No. 2,039,119. No. 2,014,913, A. H. Taylor, Wired Radio, Inc., precision control of master oscillators. No. 2,042,321, N. E. Lindenblad, RCA, a cathode ray tube oscillating system. See also No. 2,042,345 to Lindenblad, on a braking field type of oscillator. No. 2,037,160, Malcolm Ferris, RCA, signal generator. No. 2,037,897, C. W. Hansell, RCA, high frequency oscillator. No. 2,036,495, Max Pohontsch, Telefunken, on a frequency multiplication circuit. No. 2,036,562, Rudolf Bechmann, Telefunken, ultra-short wave oscillation generator. See also 2,024,864 to Dietrich Prinz and H. O. Roosenstein, Telefunken, on an ultra-short wave oscillation generator. No. 2,041,408, D. W. R. Goddard, RCA, crystal controlled oscillator. No. 2,036,719, D. Prinz and W. Wehnert, Telefunken, on a relaxation oscillator. No. 2,043,242, L. A. Gebhard, Washington, D. C., on a high frequency oscillator.

Variable Mu system. A tube having two cathodes having different electron emitting characteristics. J. M. Schmierer, Berlin, Germany. No. 2,040,341.

Power supply system. Double rectifier for plate voltages and bias voltages comprising full wave and a half wave rectifiers of the electronic type, as indirectly heated cathodes for two rectifiers and a heating circuit for both cathodes. Otto H. Schade, RCA. No. 2,037,659.

Power system. In a receiver operating on a-c or d-c, a circuit for transmitting d-c without appreciable attenuation and a-c at a step-up voltage ratio. W. Lyons, Hazeltine Corp. No. 2,036,343.

Constant current system. A high resistance connected in both input and output circuits, the resistance designed to maintain the total current there through constant irrespective of whether the cathode current of the tube is saturated. Rudolf Urtel, Telefunken, Germany. No. 2,034,011.

Broad band amplifier. Two tubes connected in a direct current amplifier system whereby potential drops across a resistance due to the anode current of the second are impressed directly upon the anode of the first tube. J. B. Knight, RCA. No. 2,026,944. See also No. 2,022,496 to Richard Feldtkeller, Siemens & Halske, Germany.

Direct current amplifier. System involving a pair of make-and-break contacts and an a-c amplifier. Paul H. Macneil, Huntington, N. Y. No. 2,043,107.

ADVERTISERS' INDEX

	Page
A	
Acme Elec. & Mfg. Co.....	63
Aerovox Corp.....	68
Aladdin Radio Ind., Inc.....	63
Allied Recording Prod. Co.....	60
American Transformer Corp.....	53
Astatic Microphone Labs.....	62
Automatic Electric Co.....	64
B	
Bakelite Corp.....	33
Biddle Co., James G.....	63
Brand & Co., Wm.....	62
Brush Development Co.....	55
C	
Callite Products Co.....	51
Carter Motor Co.....	64
Central Radio Labs.....	37
Cinaudagraph Corp.....	60
Clough Brengle Co.....	2
Continental Diamond Fibre Co.....	55
Continental Electric Co.....	52
Cornell Dubilier Corp.....	63
D	
Dumont Labs., Allen B.....	57
E	
Erie Resistor Corp.....	3
F	
Fairchild Aerial Camera Corp.....	56
Ferris Instrument Corp.....	57
G	
General Insulated Wire Co.....	52
General Radio Co.....	43
G-M Laboratories.....	62
Goat Radio Tube Parts, Inc.....	50
Guthman & Co., Inc., Edw. I.....	62
H	
Heintz & Kaufman, Ltd.....	54
L	
Leach-Relay Co.....	56
Littelfuse Labs.....	62
M	
Mallory & Co., Inc., P. R.....	4
McGraw-Hill Book Co.....	54
Mica Insulator Co.....	52
Muter Co., The.....	64
P	
Pioneer Gen-E Motor Corp.....	60
Precision Resistor Corp.....	56
Presto Recording Corp.....	50
R	
Radio Receptor Co.....	56
RCA Communications, Inc.....	60
RCA Mfg. Co.....Back Cover	
Remler Co., Ltd.....	47
S	
Shakeproof Lock Washer Co.....	39
Shure Brothers.....	61
Sigma Instruments, Inc.....	58
Sound Apparatus Co.....	54
Stackpole Carbon Co.....	
Inside Front Cover	45
Superior Tube Co.....	45
Synthane Corp.....Inside Back Cover	
T	
Thomas & Skinner Steel Prod. Co.....	62
Triplett Electrical Instr. Co.....	49
U	
United Sound Engineering Co.....	61
W	
Weston Electrical Instr. Corp.....	41
White Dental Mfg. Co., S. S.....	35, 47
■	
Professional Services.....	58
■	
SEARCHLIGHT SECTION	
<i>Classified Advertising</i>	
EMPLOYMENT.....	64
EQUIPMENT FOR SALE	
American Electrical Sales Co.....	64
Eisler Electric Corp.....	64
Eisler Engineering Corp.....	64
Electronics Machine Co.....	64
Kahle Engineering Corp.....	64
Winslow, Louis J.....	64

**ONLY SHURE "ULTRA"
Has All These Features!**



*Crystal
Microphones*



• Response approaching True High Fidelity . . . high output through new Shure "Cruciform" crystal mounting . . . Screen-Protected cartridge . . . "Moisture-Sealed" Dual-Drive Grafoil Bimorph crystal — These are but a few of the Right Engineering features that set new standards of performance and dependability in Shure "Ultra" Crystal Microphones.

• "Grille" type as illustrated — also "Spherical" and "Swivel" models — List Price only \$25 complete with cable. Licensed under patents of the Brush Development Company.

Write for Data Today!

SHURE BROTHERS, "Microphone Headquarters"
215 W. HURON ST. CHICAGO, U. S. A.

**SHURE
MICROPHONES**

AUDIO OSCILLATOR



TYPE CR-4 BEAT FREQUENCY AUDIO OSCILLATOR—Price \$77.00

- Portable, A.C. Operated.
- 10 cps to 20,000 cps.
- Reed for Calibration Check.
- High and Low Impedance Outputs.
- Direct Reading Dial. Accuracy 2%.
- Low Hum and Distortion.
- High Output; 30 volts Max.
- Drift after warmup Negligible.

Write for Catalog Sheet

UNITED SOUND ENGINEERING CO.
Manufacturers of Electronic Equipment
2235 University Ave.—St. Paul, Minn.

ASTATIC NON-DIRECTIONAL

STUDIO MICROPHONE MODEL K-2 MULTI-UNIT



ITS NON-DIRECTIONAL pickup will reproduce the multiple instruments of a symphony as faithfully as the solo performance of a single instrument or star. A dependable, clear-toned microphone with frequency response substantially flat from 30 to 6000 c.p.s. with rising characteristics to 10,000 c.p.s.—and an output level of -64 decibels (conservatively rated).

WRITE FOR BULLETIN 61

Licensed under patents of Brush Development Company—Astatic Patent Pending. Utilizing grafoil bimorph crystal element.

Featuring the **DUAL DIAPHRAGM CONSTRUCTION**

Exclusively Controlled

by



ASTATIC MICROPHONE LABORATORY, INC. Youngstown, Ohio, U. S. A.

Pioneer Manufacturers of Quality Crystal Devices

METAL COVERED FUSE MOUNTING



Designed for the new metal covered tube sets

Littelfuse No. 1126 Mounting meets requirements of Underwriters' Laboratories for 1, 1½, 2 or 3 amp. standard 3AG fuses. No mounting screw needed—time and material saved. Only 2½" x ¾" x ¼" over all. Supplied with approved fuses or without fuses.

Manufacturers, write for test samples.

Littelfuse Laboratories

4248 Lincoln Ave.

Chicago, Ill.

D.C. ELECTRO MAGNETIC RELAYS



These relays represent an improved form of sensitive electromagnetic relay which is especially suitable for use in direct current control circuits involving either "on-off" or marginal operation. The fineness and ease of adjustment of operating current permits its use under conditions where an ordinary telephone type of relay would be impractical. Supplied in 25 resistances ranging from 0.2 ohm to 10,000 ohms. Prices in quantities as low as \$1.44.

FOR COMPLETE INFORMATION REQUEST BULLETIN C. S. 559-A

G-M LABORATORIES INC.

1734 BELMONT AVENUE

CHICAGO, U.S.A.

Engineers Specify...



BRAND TURBO OIL TUBING!

THIRTY different diameters, a dozen different colors, a stock sufficient to meet your most pressing production requirements. Engineers specify Brand Smooth Inside Bore Turbo—because of its ideal insulating and mechanical properties, stable chemical structure that is unaffected when exposed to acids, oils, and high temperatures.

Also manufacturers of Turbo Saturated Sleeving and Var-nished Cambric, Cloths, Tapes and Papers. Complete catalog on request. Samples available.

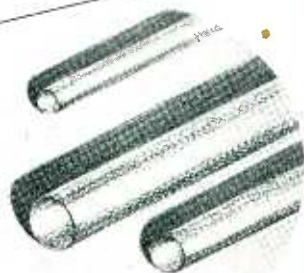

WILLIAM BRAND & COMPANY

276 Fourth Avenue, New York 217 No. Desplaines St., Chicago

SINCE 1920 THE FINEST IN INSULATION

BRAND INSULATION

GUTHMAN Coils

● Guthman Coils are **dependable!** No matter what your requirements, there's a Guthman coil that will fit the job! Send us your specifications — we'll be glad to submit samples and quote **SPECIAL LOW PRICES!**

EDWIN I. GUTHMAN and CO., Inc.
400 South Peoria Street, CHICAGO, ILLINOIS

A TRIAL WILL CONVINCe YOU

35 Years' Experience
Insures Dependability

We Manufacture
PERMANENT MAGNETS TOOLS and DIES
METAL STAMPINGS LAMINATIONS

Suppliers of
ALNICO MAGNETS

THOMAS & SKINNER STEEL PRODUCTS CO.

23d St. at Alvord

Indianapolis, Ind.

NEW INSULATION BREAKDOWN TESTER

Compact and complete. Not only indicates shorts, opens, or grounds, but actually provides for checking circuit at approved standard testing voltages. Operates from any 115 volt, 60 cycle primary circuit. Manually controlled tap switch for secondary voltages from 500 to 2500 volts.



THE ACME ELECTRIC & MFG. CO.
1447 Hamilton Avenue,
CLEVELAND, OHIO

FREE
Bulletin 140
gives all details.

BIDDLE SPECIALTIES

- "MEGGER" Insulation Testers and Ohmmeters
- "MEGGER" Capacitance Meter
- "FRAHM" Frequency Meters
- "JAGAB" Rheostats
- "APIEZON" Oils, Greases and Waxes for High Vacuum Work

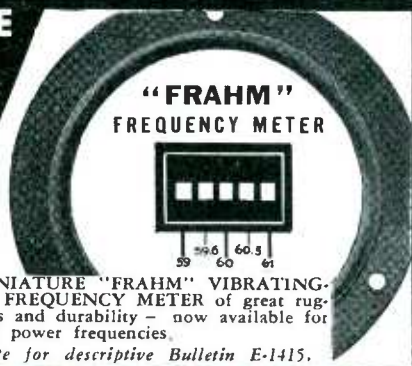

A MINIATURE "FRAHM" VIBRATING-REED FREQUENCY METER of great ruggedness and durability - now available for use on power frequencies.

Write for descriptive Bulletin E-1415.

JAMES G. BIDDLE CO.
ELECTRICAL AND SCIENTIFIC INSTRUMENTS
1211-13 ARCH STREET • PHILADELPHIA • PENNSYLVANIA

FOR
*Torrid
Temperatures*



CORNELL-DUBILIER DYKANOL TRANSMITTING CAPACITORS



High temperatures, high humidities and high voltages hold little or no terror for the Types TJ and TB Dykanol Transmitting Condensers. Specified by the United States Government, and all leading broadcast stations the Dykanol Transmitting Series has established its worthiness through years of unflinching dependable service.

Available in a complete capacity range from 600 to 25,000 V.D.C. Catalog No. 127 for the Industrial and Radio Engineer free on request.

CORNELL-DUBILIER
CORPORATION
4380 BRONX BOULEVARD • NEW YORK

We recommend the 262 kc. transformer illustrated to endure extremes in temperature, humidity, vibration and shock. Both circuits smoothly tuned with Polyiron from the top of 1 3/8" shield with practi-

cally equal frequency increment per turn.

Type	Use	Gain	B.W. 10X
L 150	conv.	78	17 kc.
L 250	diode	54	31 kc.

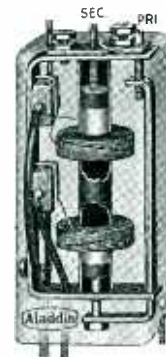

These devices manufactured under one or more of the following Johnson Laboratories, Inc., U. S. Letters Patents:

1887380	2005203	1978600	2032914	2002500	Other patents pending.
1978599	2032580	1997453	1978568	2028534	
1982690	1940228	2018626	1982689	2035439	

Polyiron Parts give you

GREATER GAIN
BETTER DX
INCREASED SELECTIVITY
LOWER NOISE LEVEL

Aladdin
TRADE MARK REG. U.S. PAT. OFF.

Write for technical data booklet 536 describing other ALADDIN products. 466-e W. Superior Str., Chicago, Ill.

We offer a comprehensive line of electrical control apparatus of proved dependability for adaptation to your products or for use in your production processes. Autelco control devices include:

RELAYS: Quick and delayed action types, for A.C. and D.C. circuits, any voltage, any contact combination.

STEPPING SWITCHES: Electro-magnetic multi-contact switches, for automatic selection of electrical circuits.

SWITCHING KEYS: A variety of locking and non-locking types in any desired contact combination.

Also cords, plugs, jacks, signal lamps, sockets, counters, etc. Write for complete illustrated catalogs.

American Automatic Electric Sales Company

1023 W. Van Buren Street, Chicago

HI-POWER FOR PORTABLE SOUND EQUIPMENT

The Carter GENEMOTOR supplies the most reliable and economical "B" Power for Class A or B amplifiers from a 6 or 12 volt battery. Output up to 500 volts. Sturdy — Compact — Quiet in operation — Requires no oiling — Guaranteed. Also can be supplied for A.C. output.



Write for Circular

CARTER MOTOR CO.
365 W. Superior St., Chicago

SEARCHLIGHT SECTION

EMPLOYMENT : BUSINESS : OPPORTUNITIES : EQUIPMENT—USED or RESALE

UNDISPLAYED—RATE PER WORD

Position Wanted, 5 cents a word, minimum \$1.00 an insertion, payable in advance.

Positions Vacant and all other classifications 10 cents a word minimum charge \$2.00.

Proposals, 40 cents a line an insertion.

COPY FOR NEW ADVERTISEMENTS RECEIVED UNTIL 3 P. M. ON THE 3RD OF THE MONTH

INFORMATION:

Box Numbers in care of our New York, Chicago or San Francisco offices count 10 words additional in undisplayed ads. Replies forwarded without extra charge.

Discount of 10% if full payment is made in advance for four consecutive insertions of undisplayed ads (not including proposals).

DISPLAYED—RATE PER INCH

1 inch \$5.00
2 to 3 inches 4.75 an inch
4 to 7 inches 4.50 an inch
Other spaces and contract rates on request.
An advertising inch is measured vertically on one column, 3 columns—30 inches—to a page.

(Elect)

POSITION WANTED

ELECTRICAL ENGINEER desires location in engineering department of radio receiver manufacturer or component parts manufacturer. Years experience in design of audio and RF testing equipment for production of multi-band receivers. Also, experience in receiver design. Location immaterial, providing salary justifies. Age 28, Eta Kappa Nu, Tau Beta Pi. P.W.-90, Electronics, 330 West 42nd Street, New York City.

WANTED

USED REVOLVING head stem machine that can be used in manufacture of neon electrodes. Six head preferred. State condition and price. P. O. Box 1113, Oklahoma City, Oklahoma.

EQUIPMENT

Air Blowers	NEW—RECONDITIONED	Flare
Vacuum Pumps	for making	Stem
Aspirators	ELECTRONIC TUBES, RADIO	Winding
Gas Boosters	TUBES, INCANDESCENT	Sealing
Spot Welders	LAMPS, NEON SIGNS	Exhaust
Gas Burners	Special machines for	Basing
Accessories	cutting hard glass	Machines

EISLER ENGINEERING CO.
751 So. 13th St., Newark, N. J.

Used Lab. Equipment

Weston—G.R.—L&N—G.E., Etc.

Meters—Bridges—Torsion balances—Inductors—Decade boxes—Analytical balances—Oscillographs—Jagabi rheostats—Signal Generators—Condensers

Write for my list

LOUIS J. WINSLOW
200 Pennsylvania Avenue Hillside, N. J.

DEPENDABLE

New and Used

ELECTRONIC TUBE EQUIPMENT

A complete line of equipment for the manufacture of Radio Tubes, New Tubes, Incandescent Lamps, etc. Write for Bulletin showing savings from 25 to 75%

EISLER ELECTRIC CORP.
534-39th Street, Union City, N. J.

HIGH GRADE NEW AND USED ELECTRON TUBE EQUIPMENT

Huge Stock of Equipment of Every Type and Variety

KAHLE ENGINEERING CORPORATION
Specialists in Equipment and Methods for the Manufacture of Neon Tubes, Radio Tubes, Incandescent Lamps, Photo Cells, X-ray Tubes, etc.
941 DeMott St., North Bergen, N. J.

NEW AND USED EQUIPMENT

Air Blowers	Meters	Flare
Vacuum Pumps	Rheostats	Stem
Aspirators	Testers	Winding
Gas Boosters	Spark Coils	Sealing
Spot Welders	Bridges	Exhaust
Gas Burners	Decade Boxes	Basing
Accessories	Transformers	Machines

AMERICAN ELEC. SALES CO.
65-67 E. 8th St., New York, N. Y.

COMPLETE EQUIPMENT

New and Used for

ELECTRONIC TUBE MAKING, LABORATORY, and SCHOOL UNITS

Glass Cutters, Spot Welders, Annealers, Flare, Stem, Sealing, and Basing Machines, Vacuum Pumps, Burners

ELECTRONICS MACHINE CO.

751 13th Street, Newark, N. J.

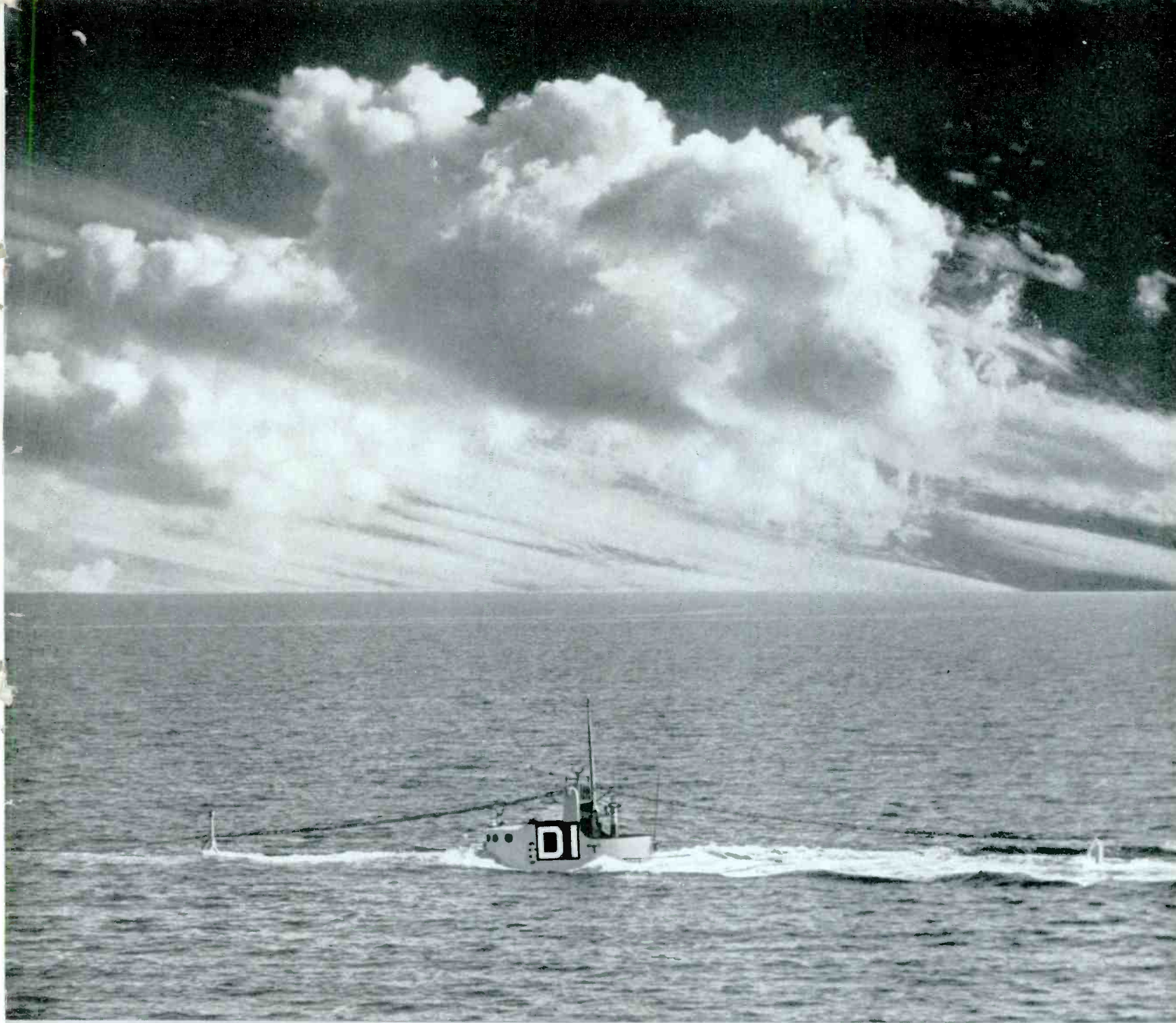

DECKS AWASH . . .

Men go below, staking their lives on the best equipment known to marine engineering . . . The use of SYNTHANE laminated bakelite in apparatus for the operation and control of submarines may suggest its applicability to your products where dependable insulation is required.

SYNTHANE LAMINATED BAKELITE
SHEETS • RODS • TUBES
FABRICATED PARTS

Send for Sample Book

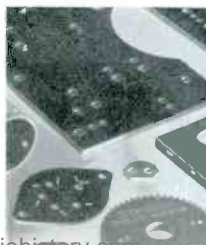

SYNTHANE
CORPORATION  OAKS · PENNA

ANNOUNCING!

THE RCA 892

Developed Especially for
**AC-OPERATED
HIGH FIDELITY**

**Broadcast Transmitters
of 5 KW Power**

STANDARD RCA Water Jackets will accommodate this new transmitting Tube.

The improved Jacket and insulated mounting shown in the illustration can be furnished at very low cost to those stations not having RCA Jackets.

Write for complete technical information on this tube to determine adaptability to your circuit.

TECHNICAL INFORMATION

Max. Plate Dissipation	10 KW
Fil. Voltage	22 Volts
Fil. Current	59.5 Amp.
Amplification Factor	50
Grid-Plate Transconductance	7000 Mmhos.
Max. Plate Voltage (Broadcast Frequencies)	15000 Volts

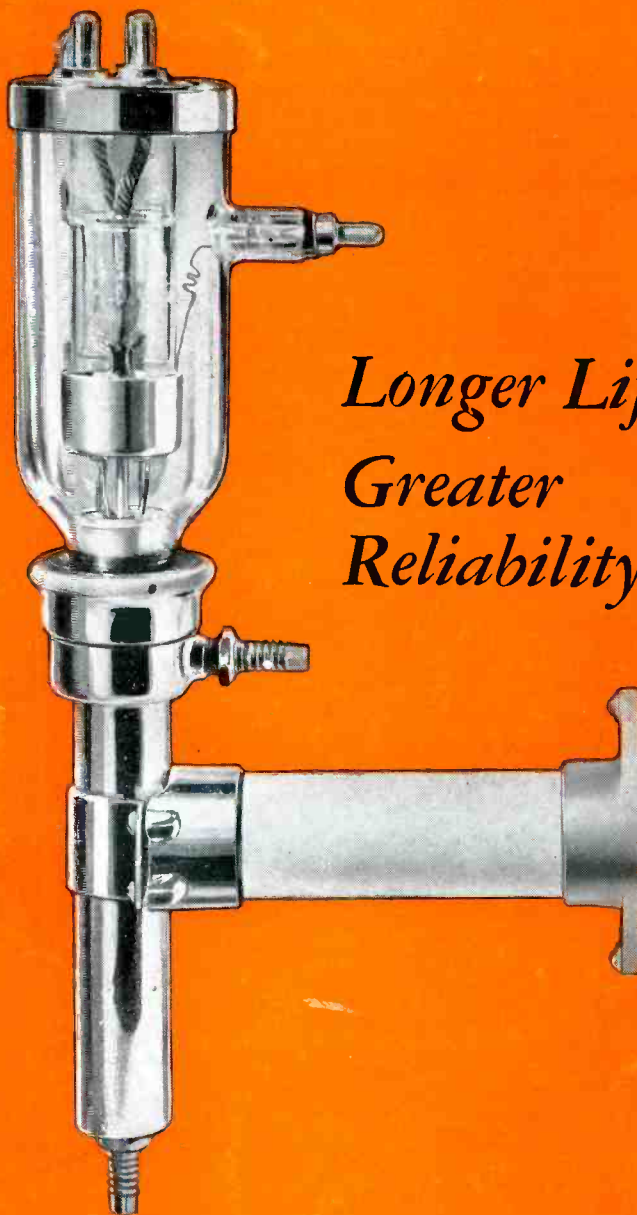

*Longer Life
Greater
Reliability*

OUTSTANDING FEATURES:

1. Two phase filament for AC operation.
2. Improved emission characteristics, giving lower distortion.
3. Filament operates at lower temperature, with resulting longer life.
4. Shielded grid mounting reduces corona.
5. Elements are treated with new process, which eliminates gas flashes.
6. Higher mutual conductance permits lower driving power.



Transmitting Tubes

Address TRANSMITTER SECTION, RCA MANUFACTURING COMPANY, INC., CAMDEN, NEW JERSEY

A Service of the Radio
Corporation of America

New York, 1270 Sixth Avenue • Dallas, 2211 Commerce Street • Chicago, 111 No. Canal Street
San Francisco, 170 Ninth Street • Atlanta, 492 Peachtree Street, N. E.